

High School Science Series

Cell: The Unit of Life



Resource Material for Science Teachers



an eklavya publication

credit page

High School Science Series

The modules

In keeping with the tradition of creating resource materials for the Hoshangabad Science Teaching Programme and carrying it forward, it was decided to develop study materials for students of higher classes. It has been long felt that text/resource material for higher classes should be prepared in keeping with Hoshangabad Science curricular tradition since science is taught as general science till class X. For the past few years Eklavya, and the Academic Resource Group associated with it, has been deliberating on the high school curriculum.

One of the ideas that emerged out of these brainstorming sessions is that, resource material on a few major areas in the field of science needs to be created for high school science students; material that would be based on a broad understanding of the curriculum and would reflect that understanding. Taking the idea forward, a few science teachers, scientists, and those working in the field of education began working on modules pertaining to different topics. So far, the framework of these modules is not rigidly defined and it is hoped that the structure of the series will become clear as work progresses.

The module **Cell: the Unit of Life**, developed by several biology teachers and other people concerned with teaching-learning process, presents the entire narrative in the light of the historical evolution of cell theory. It went through at least four drafts. Each of those were then subjected to rigorous review and feedback to give it this final shape. This intensive process has given the module a noteworthy feature, i.e., all the activities presented in the module have been done by the writers several times. Besides this, groups of teachers have also performed most of the activities. Even the photographs have been selected based on the fact that they would tally with the figures children would observe while doing the activities themselves.

Cell: The Unit of Life

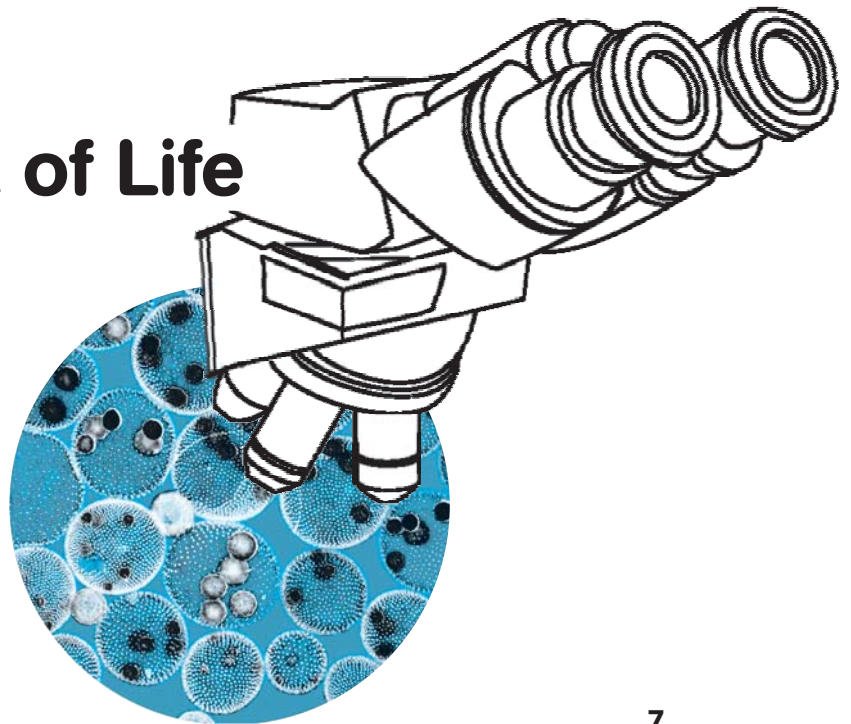

Contents

Introduction	7
Why Study cell?	7
Structure of the module	8
Cell: the discovery	10
How to use a microscope	11
Cells: Initial understanding	14
A significant observation	16
The technique of staining	16
Emergence of Cell Theory	18
Discovering new cell organelles	20
Cell theory and nerves	21
A synthesis of observations: The typical cell	22
Electron microscope and the Centrifuge	23
Two kinds of cells	24
A synthetic picture	25
Summary	26
Cell Membrane	30
Cell Wall	30
Nucleus	31
Ribosome	32

Experiments with Acetabularia	33
Golgi Body or Golgi Apparatus	34
Lysosome	34
Mitochondria	34
Chloroplast	35
Cytoskeleton	36
Vacuoles	36
Prokaryotic Cells	36
Where do cells come from?	39
Micro-organisms raise a major question	41
So is spontaneous generation possible?	43
Cells from cells	47
Advancing cell theory	52
Cell theory: The journey ahead	53
Differentiation in cells	53
Development of the Life Sciences	55
Milestones in the study of cells	58
Appendix	
Appendix 1 Know the microscope	60
Appendix 2 Are cells flat?	64
Appendix 3 few more activities	66
Index	69
Acknowledgements	71

6

Blank

Introduction

This booklet is a resource material for teachers, i.e., this module has been developed with the view that teachers can use it as a resource while introducing the topic “Cells” in their classrooms. It is left to the teacher to decide how she would use this module. If she wants, she may do entire module with her students, or may choose some portions to do in her class. Alternatively, she may also develop a completely new method of her own after studying this material.

For the past several years, Eklavya has been working in the field of education, particularly science education. The Hoshangabad Science Teaching Programme (HSTP) has been one of the most remarkable educational interventions in the country. Started in 1972 by the Hoshangabad-based voluntary organizations Kishore Bharati and Friends' Rural Centre, the programme's academic responsibility was taken up by Eklavya in the year 1983. HSTP was limited to the teaching of science in classes VI to VIII. But right from the beginning, it was felt that such efforts should also be made in the lower primary as well as higher classes.

Some work had started for the lower primary classes but due to various reasons, not much could be done for the high school students. Now initiatives are being taken in a more organized manner to create study materials for high school teachers and students, to organize trainings and offer academic support at the school level.

The module is a part of this effort. The idea is to create a number of such modules for variety of topics at the high school level. In our country, the high school years are the final period of teaching and learning general science. After this, students elect their subjects and get placed in different streams. Hence, it is important to identify topics in science that a child needs to be exposed to before completing high school. The debate regarding the selection of such topics will

continue but in the meantime it has been decided to create materials for those concepts about which there was unanimity in the group.

Why study cells?

There is a general agreement that cell is an important concept in the study of Life Sciences, and this is expressed succinctly in the cell theory. But the question still remains, why should anyone study cells? And more importantly, how can children be motivated to study this. We study certain things because they are right in front of us. Few other areas are studied as they are essential to explain direct observations. The cell does not qualify in either of these categories. In other words, if you do not have a microscope, you will never be able to see a cell. Moreover, almost all the characteristics of a living organism can be satisfactorily explained without taking recourse to the role of cells. For example, when we eat, the food reaches our stomach and intestines, gets digested and absorbed while the undigested parts are egested. The absorbed food material gets transported to different parts of the body where they are used to generate energy to do work and provide materials to build the body. The energy is obtained by the process of oxidization of energy-rich molecules and the oxygen needed for this process enters the body with our breath, and so on. From this it is evident that the body consists of different organs and that they are interconnected, but nowhere does the cell come in the picture. Nevertheless, living organisms do have certain characteristics that cannot be explained without the help of cells. For example, reproduction, especially sexual reproduction, and genetics are impossible to understand without going into what is happening at the cellular level.

Another distinguishing feature of cells is that

while it is possible to explain many of life's phenomena without it, but, on the hand, with increasing knowledge about cells, it becomes not just possible but essential to look at many of these processes in a completely different light. In fact, the knowledge about the cell and its internal structure and functions changes the very manner in which we view life.

For example, the understanding of reproduction, especially the reproduction in multicellular organisms, depends a lot on the knowledge of cells. This is because after fertilization, the life-cycle of any animal begins with a single cell. This cell does not manifest any of the physical features of the adult organism which only appear gradually. Somewhere, in this entire process, we get an inkling of the existence of some kind of a unit. The explanation of the process of reproduction has been one of the fascinating chapters in Life Sciences and many theories were put forward to explain the phenomenon. The discovery of cells and the progress in cytology has given us a better understanding of reproduction and heredity.

For example, earlier it was believed that the egg contained the organism in a dormant form which gradually grew and took the form of the adult animal. Charles Darwin believed that each organ of the animal contributed some information to the egg so that the egg acquired all the features of that individual. Many people also believed that miniscule organs were present in the sperm. Increasing knowledge about cells has helped us understand the process of fertilisation and development better and also made it possible to control these processes in ever novel ways.

Structure of the module

The study of cells in the module begins at the point where it began historically. Looking back, we find that it was Robert Hooke who first

examined a section of a piece of cork under the microscope. The figure that he saw is often printed in textbooks.

After this, there are several activities – observing thin sections of cork, onion peel, water from a puddle, leaf peel, etc. under the microscope. In fact, the microscope is the very basis of this module. We feel that viewing cells under a microscope can and will motivate the students to study them further.

The idea is to make children aware that all living organisms are made of cells. Among them, a few are made up of only a single cell, while others are made up of more than one cell. In some living beings, the cells are all alike, while in others the cells are differentiated. These observations have been woven into the historical development of the cell theory. The reason for presenting it in such a manner is to let the child experience the excitement involved in the development of a hypothesis or a theory. Usually, the manner in which theories are taught gives the impression that they have always existed in their final form and we just need to imbibe them. This module presents the cell theory in a way which will help children understand that the theory is evolving even today and that they too can be part of this process. For example, if we look back we find that one of the inferences drawn after extensive observation of cells was that organisms create cells for some reason (or

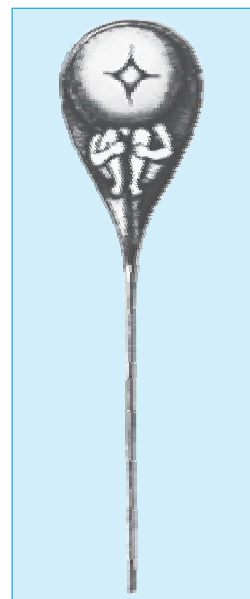

Figure 1. Artists rendering of a sperm based on ideas of Nicolaas Hartsoeker in 1694. During those days, it was believed that each sperm contained a miniscule human being.

purpose) during the course of their life. That is, cells are not the site of life's processes; rather they are their result. It took a long time to establish that the various life processes actually take place in the cells.

Presented in this exploratory fashion, it becomes clear to the child that the progress of science or any scientific theory or understanding doesn't happen at one go. It is not just the result of a sudden brainwave or insight of one particular scientist and neither does its development follow a straight path. Different ideas emerge which are then subjected to intensive discussions and debates; conjectures are made, experiments are done and all these together lead to progress in our understanding. This becomes particularly evident vis-à-vis the origin of the cell theory.

Gradually, we reach an understanding that quite a few of the life processes take place in cells. Hence, we could come to the conclusion that the cell is not the end-product of life-processes but rather an essential condition for life' existence.

We need to keep one thing in mind, all of life processes do not occur in cells. For example, a large part of the digestive process happens outside cells. As you all know, the digestion of food happens in the alimentary canal. Though the enzymes for digestion are made in cells and are secreted, yet the initial process of digestion does not take place in cells. In fact, in some animals, such as spiders, digestive enzymes are secreted out of their bodies and the digested food is then absorbed.

Although it is true that the scientists have come to know these things through experiments, but unfortunately, there are no experiments available which might be done at high school level.

We need to keep one thing in mind: all life processes do not occur inside cells. For example, a large part of the digestive process happens

outside the cells. As you all know, the digestion of food happens in the alimentary canal. Though the enzymes for digestion are made in cells and secreted, yet the initial process of digestion does not take place inside the cells. In fact, in some animals, such as spiders, digestive enzymes are secreted out of their bodies and the digested food is then absorbed.



Having observed and discussed all this, we come to the internal structure of cells. This involves observing different kinds of cells and examining various organelles of a cell through staining techniques. After examining many types of cells in this manner, we try and develop the structure of a typical cell. For this purpose, we have also included figures as seen through the electron microscope. The functions of major organelles of the cell have also been discussed.

It should be remembered that it is very difficult to explain the idea that cell is the structural and functional unit of life. The activities done here will only serve as a foundation for the child to understand/accept this idea better.

This module can be used in various ways. One, you could study it for your own understanding, which might indirectly reflect in your teaching. You could also ask the students to perform the activities given here as part of your regular teaching schedule and then take the discussion forward from there. Parts of the module could also be given to students to read. Some of you might like to do the module as a project with the students. It is entirely up to you.

For convenience, an alphabetical index has been included at the end of the module. This will help locating topics of interest to you.



Cell: the discovery

You would have surely come across the statement that 'the cell is the structural and functional unit of life'. What does this actually mean and how did we arrive at this statement?

We will try and look at evolution of this idea historically. Along with this we'll also be do a few activities and experiments and make detailed observations. For this study, you will mainly need a microscope which high schools normally have.

Three hundred and fifty years ago...

It was about 350 years ago; lenses were already being used to magnify and view objects. Many scientists were observing and describing an entirely new world with the help of microscopes. Among the scientists who deserve mention are Athanasius Kircher (1601–1680), Jan Swammardam (1637–1680), and Anthony van Leeuwenhoek (1632–1723). Robert Hooke (1635–1702) was also amongst them. Scientists of those days had a noteworthy quality; they did not restrict themselves to a particular area. You must have read Robert Hooke's name in connection with elasticity (Hooke's law). But he had also developed a microscope of his own (figure 3a). With a microscope in hand, Hooke observed a whole lot of things. One such material was a thin section of cork. Cork is made from the inner layer of the bark of the cork oak tree. He was deeply intrigued by what he saw and he made its illustration (figure 3b).

It seems that Hooke was examining a cork section under the microscope in order to understand its physical properties. For example, he might have wanted to know why the cork is so light. He might have even wanted to know why the cork does not absorb water. But when he actually placed the



figure 3a.
Robert Hooke's microscope

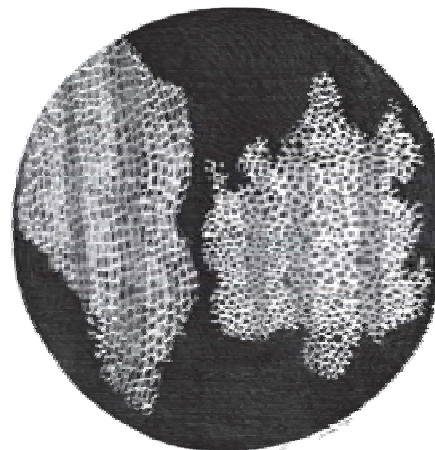

Figure 3b. cells in a section of cork as Robert Hooke described them.

How to use a microscope

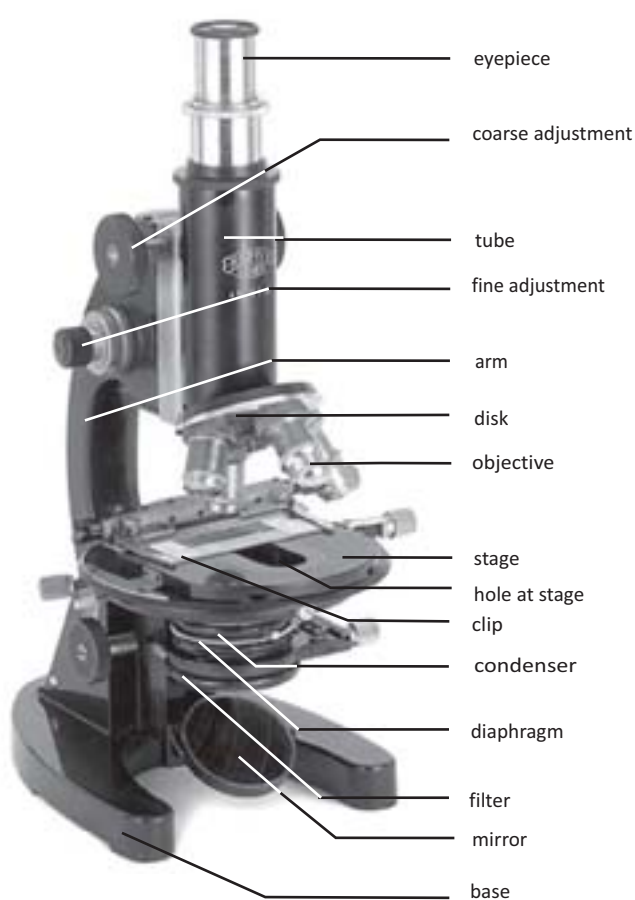

figure 2:
Compound Microscope

The proper use of microscopes is important for the study of cells. Hence it would be good to get acquainted with a microscope and the way it is used. A detailed account of the microscope is given in Appendix 1. Here a few important instructions for its use are given.

- * Clean the lens, objective, eye-piece and the stage of the microscope with a soft cloth.
- * Keep the slide prepared for observation on the stage in such a manner that the object is directly over the aperture.
- * Make sure that the objective lens which has 10X written on it is placed right above the aperture. This is the low-power objective lens. We will shortly go into how to observe things under a higher magnification.
- * Adjust the mirror so that it points towards the source of light in a way that the object receives maximum light.
- * Sometimes too much illumination dazzles our eyes and it becomes difficult to distinguish the coloured areas in the slide. On the other hand, if the light is too little, it is not possible to see the object at all. Both these situations can be taken care of with the help of the condenser. Rotate the condenser and adjust the aperture of the diaphragm to get optimum light.
- * To see the object clearly, you need to bring it into focus. For this, use the coarse adjustment first. Once the object becomes fairly clearly visible, the fine adjustment can be used to focus it properly.
- * To view the object under a greater magnification, do not use the coarse adjustment since the objective lens is very close to the slide and there is a danger that the slide may break. Hence, first use the low magnification objective to bring the object into clear focus and then rotate the disc and bring the high power objective lens over the aperture. Hereafter, use only the fine adjustment for changing the focus.
- * In most of the diagrams in this module, the magnification used to observe the material is mentioned. For example, x100 means that the diagram shows the actual object magnified 100 times.



Figure 4:
Micrographia, the book written by Hooke.



Interestingly, for years this picture was considered to be that of Robert Hooke. However, in all probability, this is a picture of von Helmont. No picture of Robert Hooke is available.

cork section under the microscope, he couldn't help but notice that the cork had many walls that intersected each other. And these intersections had created what looked like many small rooms or chambers inside the cork. Hooke named these chambers "cells". This word was derived from "cellula", the Latin word meaning "a small room". Hooke published these observations in his book *Micrographia* in the year 1665 (figure 4).

Why don't we too have some fun examining a few things under the microscope ourselves?

In these activities the emphasis has to be on observing a few objects under the microscope and drawing them. It is important to lay stress on the fact that the drawings have to look exactly like what has been seen under the microscope.

To begin with the following objects may be observed: thin section of cork, onion peel, leaf peel.

See what Hooke observed!

Activity 1a: Thin section of cork

To observe the section of a cork, soak it for about an hour beforehand. Now cut a thin section of the cork with a blade, place it in a drop of water on a glass slide, cover it with a cover slip and observe it under the microscope. Compare it with the drawing made by Robert Hooke.

Were you and your students able to see these chambers like Hooke did?

Henceforth, we shall refer to these chambers as cells.

Nowadays it is difficult to get hold of corks. But do not worry; you can observe a section of matchstick instead.

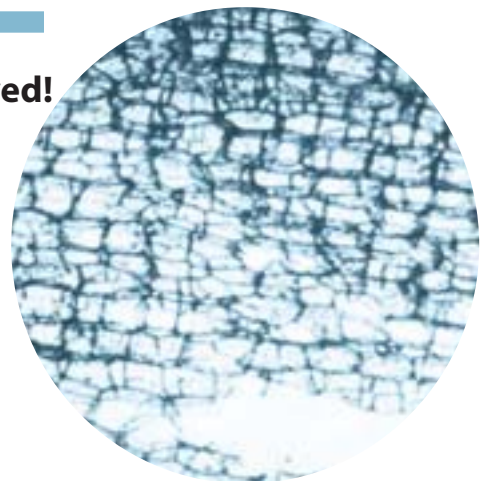
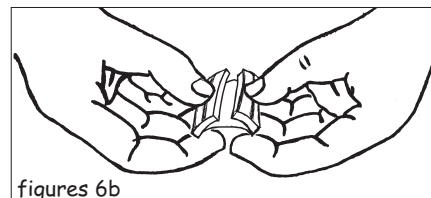
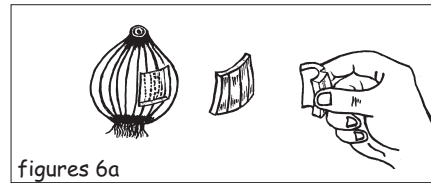

Figure 5:
Cells of a cork X100

Were you and your students able to see these chambers as Hooke did?

Activity 1b: Observing an onion peel

Peel an onion and cut out a small fleshy portion from the bulb (figure 6a). Break this piece into two small parts and try pulling them apart (figure 6b). You'll notice a thin translucent film. Separate the film (membrane), cut a small piece from it and spread it evenly in a drop of water on a slide. Make sure that it does not fold over. Cover it with a cover slip and observe it under the microscope.



Extracting a peel from an onion

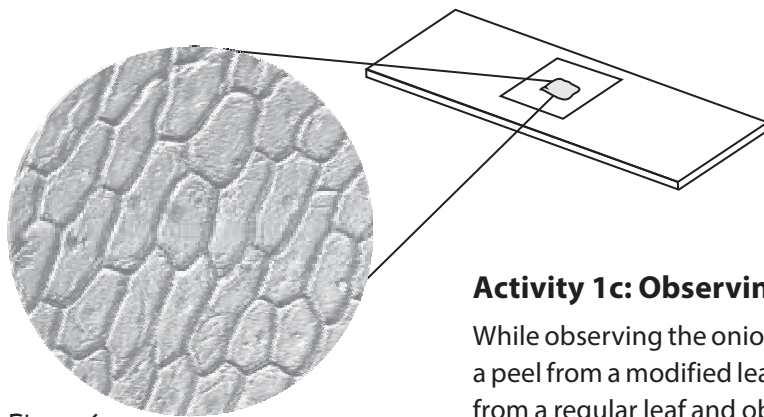

Figure 6c:
Onion peel X100

Activity 1c: Observing a leaf peel

While observing the onion peel we were, in fact, looking at a peel from a modified leaf. But we could also take the peel from a regular leaf and observe it. Any leaf can be used for this, but it is better to use a fleshy leaf, such as rhoeo, bryophyllum, calotropis etc. Make sure that the peel you observe is taken from the lower surface of the leaf, that is, it should be that part of the leaf which is towards the ground while it is on the plant. To obtain the peel, tear the leaf and take out the transparent membrane that is visible on the torn edge. Now place it in a drop of water on a slide and cover it with a cover slip.

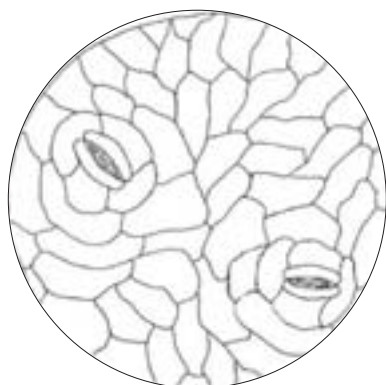

Figure 7
caption: a leaf peel

There is a significant difference between the peel from a leaf and an onion. You will see that while the onion peel is made up of the same kind of cells, the leaf peel has different kinds of cells. Make sure the students observe this difference. Figure 7 may be of help.

Compare the peels from an onion peel and a leaf peel.

- List the similarities in the two membranes.
- List differences in the two membranes.
- Are all the cells of the same size and shape in both the slides?
- Notice the variation in the cell sizes in the leaf peel.

Cells: Initial understanding

Besides Robert Hooke, there were many others observing cells. It is important to note that the cork that Hooke observed was a dead material. Later, people also examined living organisms under the microscope. However, no one could make out what these were. Although one thing was clear that all the plants and other microscopic organisms observed were made up of cells. Robert Hooke had assumed that the cells could be the channels that transported water to the entire body of the plant, or the cells might be places where the plant sap was stored. He even thought that it might be because of these tubes that cork was so light.

Till then, people had not turned their attention to animal cells. One reason might be that it was easy to examine plants. But gradually people started observing animal materials too under the microscope. In the next activity you also will observe animal cells..

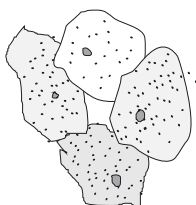

Figure 8:
Cheek Cells X 400



Activity 2: Cheek Cells

For this activity, first rinse your mouth with water. Now take a wooden or plastic spoon and scrape the inner surface of your cheek. Keep two things in mind. Firstly, wash the spoon thoroughly before using it. Secondly, don't scrape too hard, or else you could hurt yourself.

Now take the scrapings that you have got and put it in a drop of water taken on a slide. Add two drops of methylene blue solution and cover the slide with a cover slip. (To make methylene blue solution, take a pinch of methylene blue powder and mix it thoroughly in 100 ml of water.) After some time, observe the slide under a microscope. The cells that you see would be very similar to those shown in figure 8.

There are many other things you could get your students to observe. Some suggestions are given in Appendix 3. For example, observing the cross section of a stem might help if you want to show them different kinds of cells. This experiment can be done with sections of dicotyledonous plants like panwar (puwaria, chirota – *Cassia tora*), bathua (*Chenopodium aldim*), fenugreek or some other plant with tender stem. You would need to cut a thin cross section. To do this, hold the stem as shown in figure 9a and make thin sections with a sharp blade.

Put all the sections in water. Now choose the thinnest section and place it in a drop of water on a slide. Cover the section with a cover slip and observe it under a microscope.

In this case you should observe whether all the cells of the stem are same or whether there are differences. Figure 9b shows how the section would look under the microscope. The students can note the number of different kinds of cells. As it is, they have already observed diversity of cells in the leaf peel.

The main objective behind these experiments is to see if all organisms are made up of cells and whether all cells are alike. Help students notice the variety. This is important for the discussion which follows.

It is important to note that observing animal cells is relatively difficult. One reason is that plant cells have a thick wall around them while animal cells are only demarcated by a thin membrane. The thick partitions seen between plant cells are called cell wall. When the plant materials are placed under the microscope, this cell wall is clearly visible. In fact, the cell wall marks one of the major differences between plant and animal cells.

When we examine a cell, we only see the cell wall or the membrane. This given us the feeling that the cell is empty space. In fact, Robert Hooke thought the same and hence the name 'cells'. But

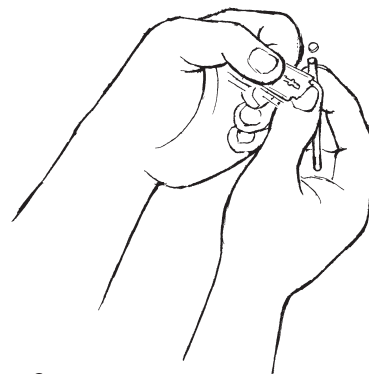

figure 9a.
Method for cutting cross sections

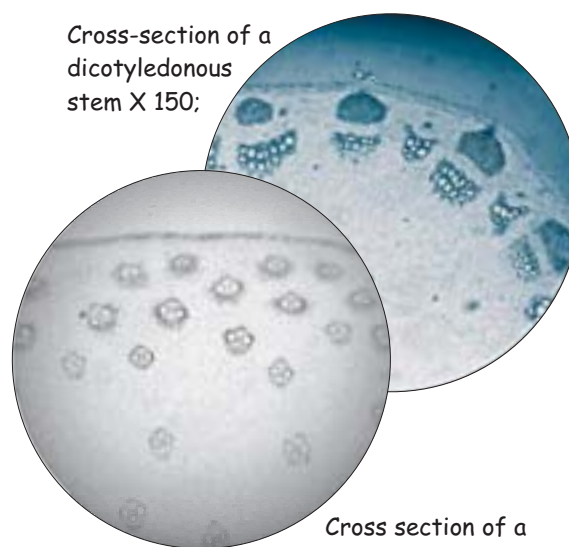

Figure9b.

Cross-section of a dicotyledonous stem X 150;

Cross section of a monocotyledonous stem X 150

We expect that after each observation, the students have drawn a good diagram. Come to think of it, these diagrams are all that will be left with them after they have done all these experiment.

later observations made it clear that cells are not just empty spaces. We shall also make some such observations a little later.

A significant observation

The observations of a scientist named Robert Brown (1773–1858) have made a significant contribution to our understanding of cells. Among different parts of a cell, the nucleus is the most well known. Though it is generally believed that Felice Fontana (1730–1805) and a few other scientists first saw the nucleus in the epithelial cells (the outermost layer of the animal body) in the 18th century, Robert Brown is given the credit for observing the nucleus in different kinds of cells and recognizing that it was an integral part of all cells. While observing cells in the epidermis of orchid leaves, Brown noticed a near-circular spot that was slightly more opaque than the surrounding areas (figure 10). He noticed that similar structure was present in other cells as well. Brown considered this structure an essential part of the cell and called it nucleus. This was in the year 1831 which means that there was gap of over hundred seventy-five years between the first recorded observation of cells (around the year 1650) and the observation of the nucleus. Incidentally, this is the same Brown whose name is associated with Brownian motion.

This is what Robert Brown saw when he observed the nucleus for the first time. Here we see about 20 cells in an orchid leaf epidermis; in each cell the nucleus can be seen clearly. We can also see three stomata here: stomata are the pores through which the leaves exchange gases with the atmosphere. During these years, major improvements were made in microscopes as well. In the early days, there used to be just a single lens in the microscope. This is known as a simple microscope. Gradually better lenses were made. Compound microscopes, which used a combination of more than one lenses, were also invented. (It is generally believed that the first compound microscope was made in the year 1595 by the scientist named Janssen. Robert Hooke's microscope too was a compound microscope.) With the advent of compound microscopes, more detailed observations were possible.

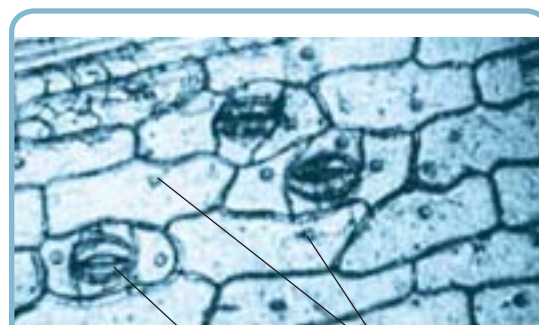

Figure 10
stomata cell

This is what Robert Brown saw when he observed the nucleus for the first time. Here we see about 20 cells of the epidermis of an orchid; in each cell the nucleus can be seen clearly. We also see three stomata here: stomata are those pores through which the plants exchange gases with environment.

The technique of staining

By this time, the efforts of several scientists had established the fact that all living organisms have cells and that each cell has a nucleus. Why don't we also observe that part of the cell which is considered to be an essential part of all cells? For this, we need to use a special technique which was not available to Robert Brown. The technique is based on the fact that there are a few coloured substances or dyes that get attached to different parts of a cell. In other words, with these dyes we are able to give a different colour to each part of the cell. This helps to highlight that particular area in the cell. These colouring agents are known as stains and the process is called staining. We shall use this technique to observe the nucleus. For this we need to use a stain called saffranin. People have found that red ink also works as an appropriate dye for this purpose. Hence, you could also use red ink for this experiment. By the way, you have already made use of the staining technique in activity 2 since methylene blue is also a stain.

Activity 3a: Nucleus in onion cells

For this, you need to peel a membrane from an onion once again. Now keep this membrane on a slide and add 1-2 drops of the dye (safranin, methylene blue or red ink). (To make safranin solution, dissolve $\frac{1}{4}$ tea-spoon of safranin in 100 ml of water.) Cover this with a cover slip and leave it for about five minutes. Now add water drop-by-drop from one side of the cover slip while absorbing the extra water with a filter paper from the other side. This will help in washing away the extra stain. Now observe the slide under a microscope.

Ask the students whether they are able to see red spots within the cells. This is the nucleus. Figure 11 may be helpful.

Activity 3b: Nucleus in cheek cells

You could also take cheek cells, stain them with safranin or methylene blue and try to observe the nucleus in them.

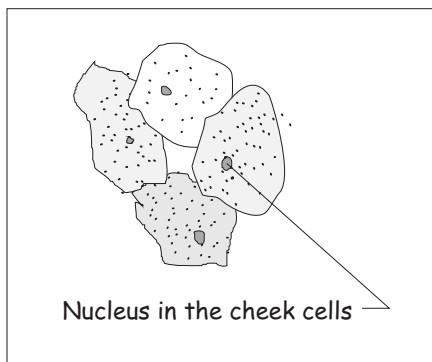

The dye gets attached to different parts of cell in various measures during staining process. This helps us to not only see the parts clearly but also get an idea about the chemical composition of these parts since dyes react with cell component differently.

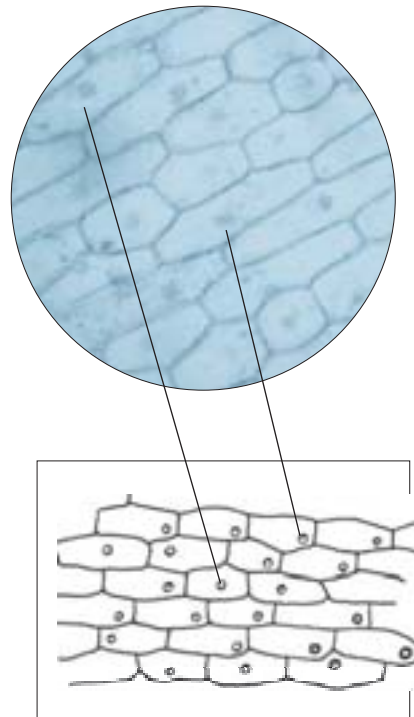

Figure 11:
Nucleus of an onion cell

Activity 3c: Nucleus in Aloe vera leaf cells

Extract a peel from an *Aloe vera* leaf. Keep it on a slide and observe it under a microscope. You will be able to see the nucleus very clearly even without staining by adjusting the light falling on the material. To do this, tilt the mirror or adjust the condenser of the microscope slightly. Structures inside the cell can be seen more clearly by reducing the amount of light with the help of the condenser, Try it for yourself and see what you can observe.

Were you able to see the nucleus in all the cells?

In the following sections you will find that nucleus is one of the most significant organelles in the cell. However, it took many years for its function to be revealed. Meanwhile, scientists made a lot of conjectures about what its role could be.

Emergence of Cell Theory

The observations so far made it clear that all living beings are made of cells and that each cell has a nucleus. Around 1838-39, two scientists expressed this in the form of a theory. The scientists were Matthias Jakob Schleiden (1804-1881) and Theodor Schwann (1810-1882). Schleiden was a botanist while Schwann was a zoologist. For the record, it should be mentioned that quite a few scientists had recognized by that time that cells were present in all living organisms and were expressing it in their own ways. However, Schleiden and Schwann were the first to claim that this fact was true for the entire plant and animal kingdom. In other words, they took the first bold step of generalizing from observations and coming up with a theory which was applicable to the entire living world. And because of this, the credit for propounding the cell theory goes to them. What is noteworthy is that there was a gap of about 200 years between Robert Hooke's first observation of cells and the formulation of the cell theory.

An important point needs to be kept in mind here. In life sciences, it is very difficult to make generalizations, as it is impossible to study all organisms. Hence, at some stage during the evolution of our knowledge about any concept, it becomes imperative to decide that a certain construct can be considered as fundamental or be elevated to the status of a general principle.

In the year 1838, Schleiden stated that all plants are made up of cells or their products. In other words, the entire plant body is made up of either cells or materials produced by cells.

On the other hand, Schwann stated this a tad differently: "the elementary parts of all tissues are formed of cells" and that "there is one universal principle of development of the elementary parts of organisms... and this principle is the formation of cells." In other words, most parts of an animal are made up of cells and these parts develop by the constant creation of new cells.

These statements by Schleiden and Schwann are considered to be the beginnings of the cell theory. If we consider both accounts, the crux of the theory that emerges is that all living organisms are made of cells and their growth and development occurs through the creation of new cells.

These statements gave birth to a whole lot of new ideas in the Life Sciences. The first and foremost among these was that, be it an animal

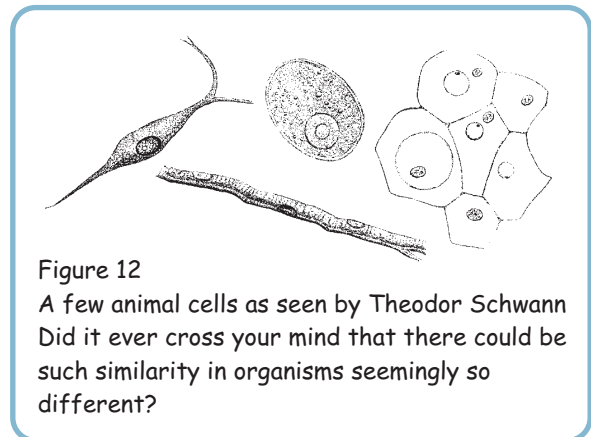

or a plant, its body is composed of cells. Whoever would have thought that there would be such fundamental similarity in the make up of rhinos and roses?! In other words, the cell theory established a connection between the plant and animal kingdoms. The unification of the world of flora and fauna that began with this has continued to be strengthened at various levels over the years.

Secondly, the study of cells became a significant aspect in the understanding of life. Indeed, the cell can be called one of the most fundamental concepts in modern biology. The concept of organic evolution was already emerging. The basis of this concept was that organisms change continuously. More specialised disciplines like genetics and the study of DNA etc. came in much later. In a way, these latter concepts could be

termed as offshoots of the basic cell theory. The cell theory rests on the understanding that the cell is the minimum or basic unit of life.

Thanks to the work of scientists like Hooke, Schleiden, Schwann, Virchow, Brown and many others, the following components of a cell had come to light thus far:

- i. cell wall and cell membrane (in plants) or only cell membrane (in animals);**
- ii. cytoplasm, the viscous liquid filling the interior of cell; and**
- iii. nucleus**

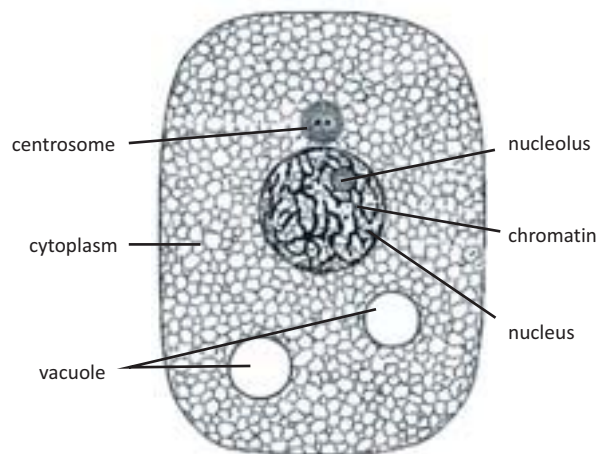

Figure 13.

A picture depicting 1922 understanding of the internal structure of a typical cell. This figure is based on the picture published in the book *The Cell in Development and Inheritance* by Edmund Wilson in that year.

It is generally said that the cell theory is the gift of Schleiden and Schwann. Yet on the basis of the details given above, is it proper to attribute cell theory to only these two scientists? In fact, is it at all correct to attribute any particular theory in science to just one or two individuals?



Matthias Schleiden



Theodor Schwann

Legend has it that Schwann and Schleiden were discussing their observations about different cells over a cup of coffee after dinner one night in the year 1838. As Schleiden was talking about the nucleus that he had found in plant cells, Schwann remembered that he too had seen something similar in animal tissues. Both the scientists hurried to Schwann's laboratory and looked at the slides. This discussion resulted in the creation of two individual versions of the cell theory: one by Schleiden in 1838 and another by Schwann in 1839.

Schwann made the following statements about cells in his book:

- 1. The cell is the structural and functional unit of all organisms.**
- 2. The cell has a dual role: one, in the form of an independent unit; and two, in the form of a structural unit in the organisms.**
- 3. Cells are formed by free cell formation, just like crystals.**

Discovering new cell organelles



Rudolph Virchow 1821-1902

A strange fallout of the cell theory

One of the impacts of the cell theory was that it led to the perception of living organisms in terms of their constituent parts. In other words, people began to believe that an animal was a sum of its cells. Look at an example. The cell theory led to the idea of cell pathology. According to this concept, illness was some sort of disorder in the cells. Particularly, a scientist named Rudolph Virchow tried to establish this idea through his book *Cell Pathology* (1858). As the understanding of cells and their relation with the organism grew, this idea was refined and took the form of molecular pathology.

It soon became evident that the cytoplasm was not a homogeneous fluid. Some biologists regarded it as fibrillary, whereas others described it as reticular, alveolar or granular. There were several reasons for these different descriptions. The major reason was the manner in which the material was prepared for observation, how it was stained and fixed. In the course of these processes, the cytoplasm coagulated differently giving rise to different appearances.

Gradually the techniques improved and the internal structures took a more definite shape. The microscope and methods for study slowly became more advanced. As a result, by the end of the nineteenth century almost all the major components of the cell had been discovered. For example, in the year 1897, the ergastoplasm (that is, endoplasmic reticulum) was described. Similarly, a few scientists saw mitochondria and it was named as such in the year 1898 by Carl Benda (1857-1933). In the same year, Camillo Golgi (1843-1926) discovered another structure in the cell, named the Golgi body in his honour. While studying various organelles in the cytoplasm, scientists also learned that the nucleus itself was not an undifferentiated entity. It was also constituted of many different structures. It might not be possible for the children to see all these organelles and the internal details of the nucleus.

You have already observed the nucleus. The mitochondrion is another significant organelle, but it is difficult to observe. The mitochondria are scattered all over the cytoplasm. If you would like to try and observe mitochondria, please refer to the method given in Appendix 3.

While mitochondria are found in both plant and animal cells, there is one organelle found only in plant cells and that is the chloroplast. It is easily seen and can be found in the green parts of many plants.

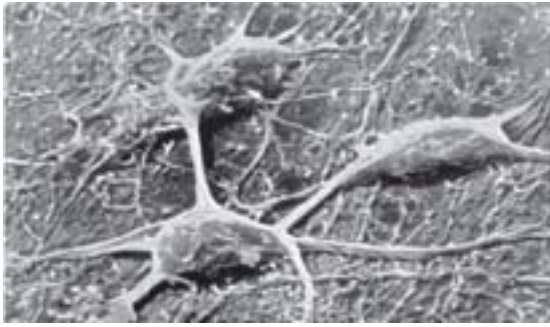

Nerve cells of the human brain

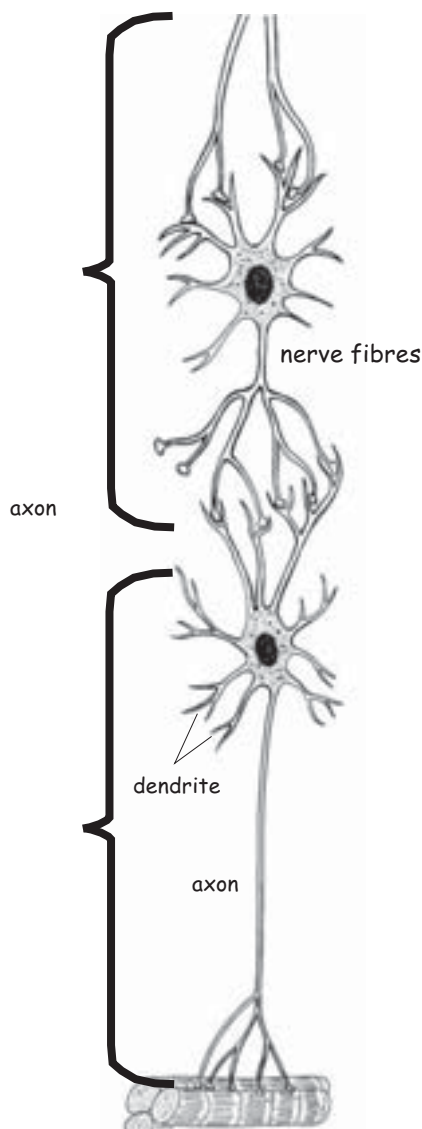

Figure 14:
Two adjacent nerve cells are shown here. Because of such proximity, it was difficult to ascertain where one cell ended and the other began.

Cell theory and nerves

Mention must be made of a difficult challenge faced by the nascent and evolving cell theory. While the cell theory claimed that the bodies of all living organisms were made up of cells, observations of the nervous system seemed to indicate that this particular system was not made of cells, rather it was spread out like a continuous network throughout the body. The nervous system is extremely complicated and hence, it was quite difficult to study it.

It was Karl Dieter (1834–1863) who first observed the nerve fibres in the middle of the 19th century. He saw that these consisted of a soma (cell body), dendrites (extensions of the cell cytoplasm) and nerve fibres (axon). However, it was so complicated that he was unable to establish the connection between the soma and the branch-like extensions emerging from it (dendrites).

Next, another scientist stated that the sensory and motor nerves are directly connected to each other in the spinal cord. Slowly people came to believe that all the nerves in a body are connected to each other. That is, nerves form a network of cytoplasm that makes communication between various parts of the animal body possible. It was assumed that nerves were not constituted of separate cells; instead they were a complex network of cytoplasm (gigantic syncytium).

The primary reason that led to this misleading notion was that it was extremely difficult to study nerves, as it was tough to isolate a single neuron for study. Besides, the branches on the ends of dendrites were also not visible with the then available magnification and staining techniques. It seemed as if the fibres were continuous. As a result, nerves were accepted as an exception to the cell theory.

The scientist Wilhelm His has been credited with establishing that the soma and its branch-like extensions form a separate unit. He also proved that the axon terminates after extending upto a particular point and there is a gap before the next nerve cell's dendrites begin. Thus, nerves are made of independent cells too. He also made it clear that the interaction between the nerves is possible not because of their continuity but due to their proximity. After this, the nervous system also got included within the ambit of the cell theory.

Figure 15a:
Chloroplast in the
hydrilla leaf X100

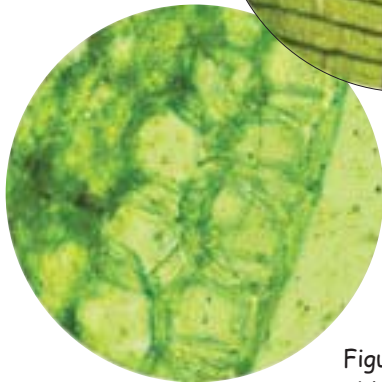
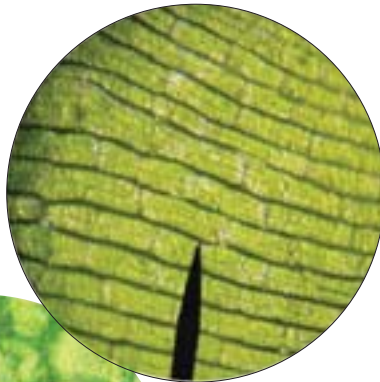

Figure 15b:
Chloroplast in a leaf
X400

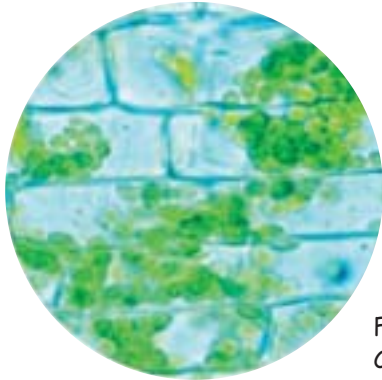

Figure 15c:
Chloroplast in
aquatic plants X400

Activity 4a: Chloroplast in hydrilla leaf

Hydrilla is an aquatic plant with very small leaves. In fact, any aquatic plant can be used for this activity. Keep a hydrilla leaf on a slide and observe it under a microscope. The chloroplasts are visible as green dots in the leaf cells. If you use the high power objective, you'll also be able to see the chloroplast streaming in the cells at the edge of the leaf.

Activity 4b: Chloroplast in Rhoeo

Extract a peel from the greener surface of the Rhoeo bicolor leaf and observe it under the microscope.

Are you able to locate green dots in the cells?

These are the chloroplasts.

Activity 4c: Chloroplasts of different shapes

Get some algae from a pond. Algae consist of thin filaments. Place one or two such filaments on a slide and observe these under a microscope.

Draw pictures of the chloroplasts that you see. %

A synthesis of observations: The typical cell

We observed various kinds of cells and also saw different organelles within the cell such as the nucleus and the chloroplast that are easily visible. As is evident from the above account, it took about two-two and a half centuries before all the structures in the cell were described. This gradual development closely corresponded with

improvements in methods and techniques. As new techniques developed, it became possible to study the cell in greater detail and our understanding of the cell's internal processes also grew.

As we noticed, the early microscopes used to study cells were optical microscopes, which you

have also been using. In these, light rays are used to examine the materials. Different parts of the cell interact with light differently which make it possible to visualize them separately. Use of lenses helped magnify the object and development of compound microscopes enhanced our power of observation many fold.

Then came the techniques of staining. There are certain substances that get preferentially attached to some parts of the cell and colour them. This enables us to differentiate between them. Florescent staining has also been a very useful technique.

However, the magnification power of optical microscopes is limited to about 3000. In other words, with these optical microscopes the image can be up to around 3000 times the size of the original object. This was the limit of magnification till around 1940.

During the 1940's, emergence of two new techniques brought about a revolutionary change in the study of cells. These were electron microscopy and the use of centrifuge

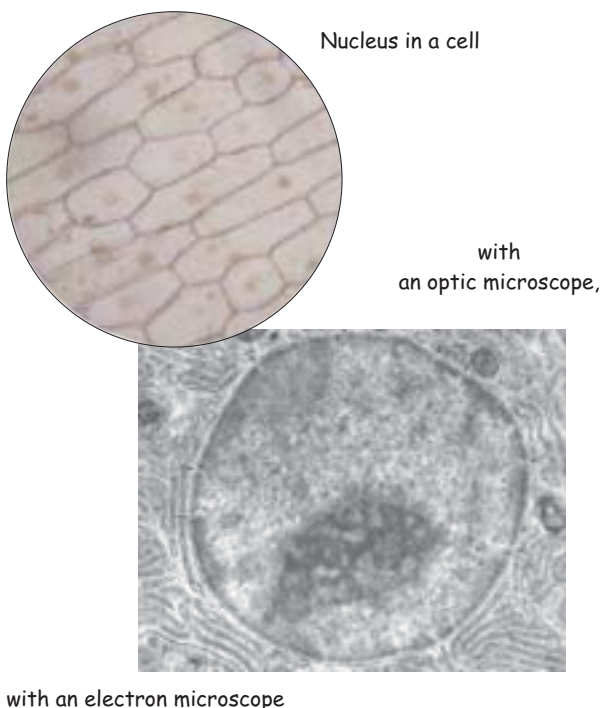

Electron microscope and the Centrifuge

With the help of an electron microscope it is possible to get a magnification of about ten thousand to a million times the size of the original object. Thanks to such astounding magnifications we have been able to see the cell in great detail, and the structure of its various organelles has been revealed.

Centrifugation has also proved to be an effective technique in the study of cells. How does this work? If the solid particles are suspended in a liquid medium, they slowly settle down at the bottom due to gravity. The rate at which these particles settle down depends on their respective densities. In a centrifuge, the suspension is spun at very high speeds so that the effective force on the solid particles is increased leading to an increase in sedimentation rate. In order to study cells using this technique, the cell membrane is broken open and the cell contents suspended in a fluid medium and centrifuged. This leads to the various organelles getting separated. With the help of this technique the functions of different organelles can also be studied.

With the help of these techniques it has been possible for us to get a detailed picture of the cell. The account that follows is a combined result of

In the microscopes that we generally use, light interacts with the material under observation. Different parts of the material affect light differently. In the electron microscope electron beams are used instead of light. The wavelength of the electron beams is 100,000 times less than that of light. Because of this, the object can be magnified to a much greater extent. A magnetic lens is used in place of a glass lens to focus the electron beams in the electron microscope.



Ernst Ruska

Max Naal

There are two types of electron microscopes: the transmission microscope and the scanning microscope. Electron microscopes enable us to see the structures of cell organelles in great detail. The importance of the electron microscope was acknowledged by awarding the Nobel Prize to Ernst Ruska who had developed it in 1932. However, he was given this award only in 1986, a full 54 years after his achievement!

all these efforts. In fact, the study of cells has progressed along three main streams. The first stream is the study of the chemical composition of the cell and its components. The chemical compounds present in the cell, their structures and so on have been studied in great detail. In this field of study, we can start with atoms and molecules and try to understand how they combine to give the complex chemical compounds that are eventually organized into a cell.

Another stream relates to the cell's functioning. In this, we consider the cell to be a part of an organism and treat it as the smallest unit for the proper functioning of the organism. In other words, this is one level of organisation. The objective behind viewing cells from this angle is to study the interactions between cells and try to understand how different cells work in co-ordination to allow the entire organism to function as a coherent whole.



a bacterium cell

The third stream is a combination of the first two. In this, we also try to understand the various sub-units of the cell, the manner in which their structures are maintained and how they function. Whereas the cell is the smallest unit in plants and animals, in some organisms it is not only the smallest, but the only unit. These organisms are made up only a single cell. Some of the micro-organisms observed by Leeuwenhoek are composed of only one cell, and we have also observed some of them. Yeast, bacteria, paramecium, euglena, amoeba are unicellular organisms. It is quite astonishing that all the basic life functions (nutrition, respiration, reproduction, excretion) occur within that single cell in these organisms..

Two kinds of cells

Cells can be broadly classified into two types. There are some cells that have a distinct nucleus. These are called eukaryotic cells. Then there are cells that lack a distinct nucleus. These are called prokaryotic cells. Bacteria are examples of prokaryotic cells. Here we will be talking primarily about eukaryotic cells. There are important differences between eukaryotic and prokaryotic cells. We shall discuss these differences towards the end of this chapter.

A synthetic picture

We observed quite a few cells during various activities in this module. Superficially, there are many differences among these cells. If that is the case, what is point in saying that the cell looks like this? Textbooks usually include figures of a plant and an animal cell. But when we actually see any cell under the microscope, its image does not match the ones given in books. That is because the picture depicted in the textbooks is that of a typical plant or animal cell. This picture does not belong to any particular cell; rather it is a composite picture based on the observations of many cells.

This picture is constructed on the basis of information derived from various sources too. Primarily, cells are studied under the optical microscope. When we observe the cell with a compound microscope, we get to see only the following organelles: cell wall, cytoplasm, nucleus, chloroplast and the mitochondria.

However, when the same cells are observed under an electron microscope, a few other structures become visible. In a comprehensive illustration of the cell, these organelles and details are also included.

It is not at all necessary that all the organelles shown in the typical plant or animal cell would be found in all the cells, though all cells might have a few organelles in common. For example, chloroplasts are always shown in the typical plant cell, yet all plant cells do not have chloroplasts. You too must have noted that chloroplasts occur only in some cells of green parts of the plant, like the leaf and tender stem.

So how do we understand and explain a typical cell? We try and create a model of what a cell is. The organelles that feature in most of the cells are included in this model. The typical cell provides a way to study cells. Once we arrive at such a model, we can compare any cell with it.

Apparently plants and animal cells seem very different, yet on a closer look, there is not much difference between them. The structure and size of both cells are similar. Although sizes might differ greatly, yet the diameter of most cells is about one hundredth of a centimetre. There is very little difference in the cells of organisms of different species. Almost similar organelles are found in all the cells..

If you consider the cell at the level of fundamental processes, there is not much difference between the cell of a human being and a rat or the cell of a

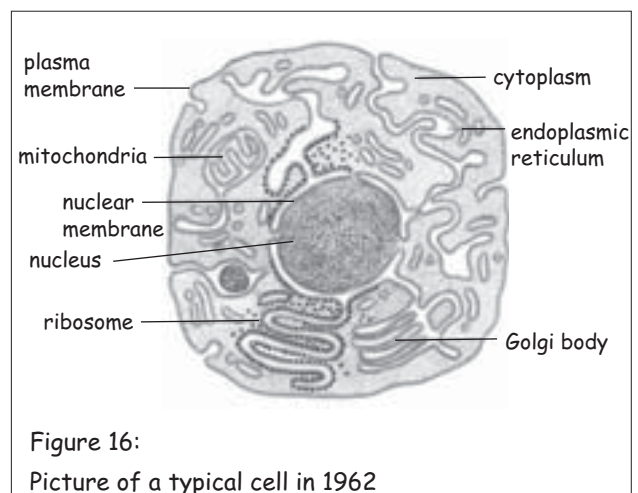

Figure 16:
Picture of a typical cell in 1962

moss and a rose. In the same way, cells of an animal or a plant are likely to have more commonalities than differences. For example, cells of a liver and kidney may be somewhat different, yet they are very similar. When there is greater similarity rather than differences, it helps to have a composite figure that highlights the similarities. The typical cell is an artificial construct that highlights such similarities. To facilitate studies, two distinct models of the typical cell have been made: a typical plant cell and a typical animal cell.

Cells: So small, so many

In 1663, Robert Hooke had estimated that about 1 billion cells would be present in one cubic inch (approximately 15 cubic cm.) of cork. So you can imagine how small these cells actually are. There are about 2 trillion cells in the body of a new-born baby; and the figure comes close to 60 trillion in an adult. When you look at your favourite painting, you do so with the help of 125 million photosensitive cells present in the retina and this information reaches your brain through 1 million nerve cells. When you donate blood you give away about 5.5 billion cells at one go. And each day your body discards about 1 per cent of the total number of cells (that is 600 billion cells!) and creates new cells in their place.

Let us try and get some idea about the size of these cells. From the figures given above, it is clear that the cells are very small in size. But exactly how tiny? Some bacteria are just 0.2 micrometers in length. One micrometer is equal to $1/10,00,000$ (10^{-6}) of a metre, that is, $1/10,000$ of a centimetre or $1/1000$ of a millimetre. On an average, animal cells are 20 micrometers long. Incidentally, one needs to keep in mind that a few animal cells can be quite large. For example, the diameter of the ostrich's egg cell is roughly 7 cm. Please note, the ostrich egg is just the yellow portion (yolk). Similarly, a few nerve cells in a giraffe's



grains of rice,
about 8 mm. each

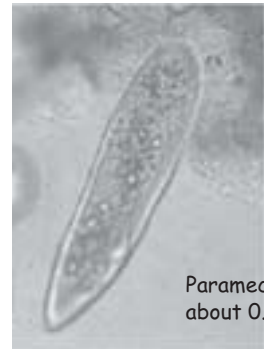

Paramecium,
about 0.25 mm.



image of nerve cells as
seen under the scanning
microscope,
about 0.004 mm



Amoeba,
about 500 micron



E. coli bacteria,
about 3 micron

Summary

In this section, we shall summarize the history of study of cells and discuss a typical cell. According to the initial cell theory, the cell was a box-like structure filled with some transparent material. It was believed that this substance contained a

miraculous vital force and was called protoplasm. Later, the word protoplasm was abandoned and replaced by the term cytoplasm. See box about the nomenclature of protoplasm.

By the 1830's, it had become clear that all plant and animal cells had an oval/spherical structure slightly darker than cytoplasm. This was called

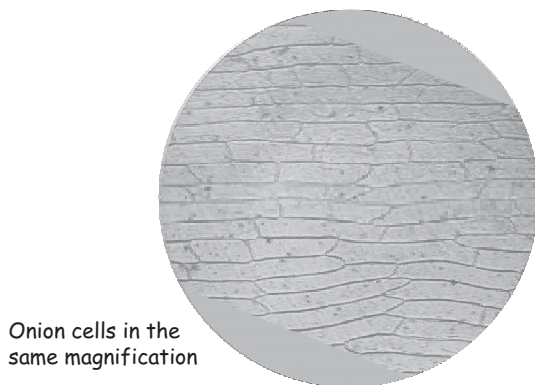
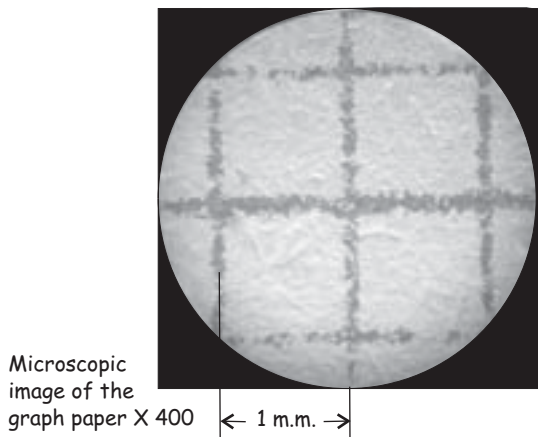

Figure 17:
Measuring cell size with graph paper

body extend from its legs to the brain and are about 3 m long.

However, barring a few exceptions, almost all cells in a plant or an animal are similar in size. And the size of cells of different organisms varies between 1 and 100 microns. Children (and sometimes even adults) have mistaken notion that the cells of large organisms are bigger than the cells of small organisms.

While observing the cells you too can estimate their size fairly well. Particularly, it is quite easy to find out what the size of the cells in an onion peel would be.

The method makes use of a graph paper with 1 mm squares. Observe the graph paper under the microscope using the low power. Without moving you eyes, see how many millimetres you can see at a time along the diameters of the view. Now observe the slide of an onion peel in the microscope under the same magnification and try to count the number of cells along the diameter you see at one go. These observations will give you a tentative idea about the length and breadth of a single cell. However, you might face a problem since the lines on the graph paper look very blurred under the microscope and it is difficult to make out individual lines. Hence, for this activity, we need a graph paper with finely drawn and sharp lines.

the nucleus and the membrane that separated it from the cytoplasm was named the nuclear membrane.

Then, during the 1880's and the 1890's, it became clear that the cytoplasm itself was not homogeneous; it was found to be a granular and jelly-like substance. The best microscopes available at that time revealed granular particles scattered in the cytoplasm. These bodies were

oval or cylindrical in shape. These granules were named mitochondria. Our understanding of the structures within the cells did increase exponentially after the development of electron microscope which became available during the 1930's. With the electron microscope, the nucleus and the mitochondria could be seen in greater detail. It came to light that even their structures are quite complicated. The electron microscope

A Republic of living elementary units

We saw that the evolving cell theory gradually became a common structural foundation for Life Sciences. No matter how Schwann or Schleiden had described it, according to one scientist the crux of cell theory was that all organisms were republics of living elementary units.

This is a very apt statement of the cell theory. We will see that any cell plays a dual role like a citizen in a republic. On the one hand, it has an independent existence, and it performs certain functions that help keeping it alive. On the other hand, being part of an organism, the cell carries out activities that are essential for the life of the organism.

Take an organ of our body for example. The cells in our pancreas respire, use nutrients to build

various molecules and also divide to give rise to new cells. These functions are essential for their survival. But there are cells in the pancreas that secrete enzymes and hormones as well. The enzymes help in digestion while hormones perform other functions in the body.

Many cells coming together to give rise to an organism demonstrate another recurring theme in biology. When some units come together to give rise to a new level of organisation, the characteristics of this new unit are not merely the sum of its constituent units. At this higher level of organisation, some new characteristics appear that were absent in the constituent units. These are called emergent properties and are seen at every level of organisation of life.

also made it clear that the cytoplasm too is not homogeneous in nature. The pictures of the plant and animal cell that were revealed by these observations are given here (Figure 18).

So the story of cell, which began with a membrane filled with some clear fluid, gradually got new structures. The cytoplasm began to be seen as a network of fibres, membranes and other tiny particles. The homogeneous fluid was now viewed as having membranes woven into a rug-like pattern. Along with this it also became clear that the different functions performed by the cell occurred in its organelles. This gave rise to questions as to how does a cell function like a co-ordinated unit. We shall not go into this question here. Instead, we shall conclude the discussion of cell structure with a brief description of a few common organelles.

Protoplasm vs. cytoplasm

For a long time it was believed that the essence of life was stored in the fluid found inside the cell. Hence this was named protoplasm which means life fluid. But when it became clear that the fluid is basically a medium in which various particles and membranes float around and that the functions of the cell actually take place in these organelles, it began to be understood that life resided in this organisation. In particular, after the discovery of the nucleus, it was recognized that the material inside and outside the nuclear membrane are different. Hence, protoplasm was renamed as cytoplasm, that is, cell fluid. The fluid inside the nucleus came to be known as the nuclear fluid or nucleoplasm.

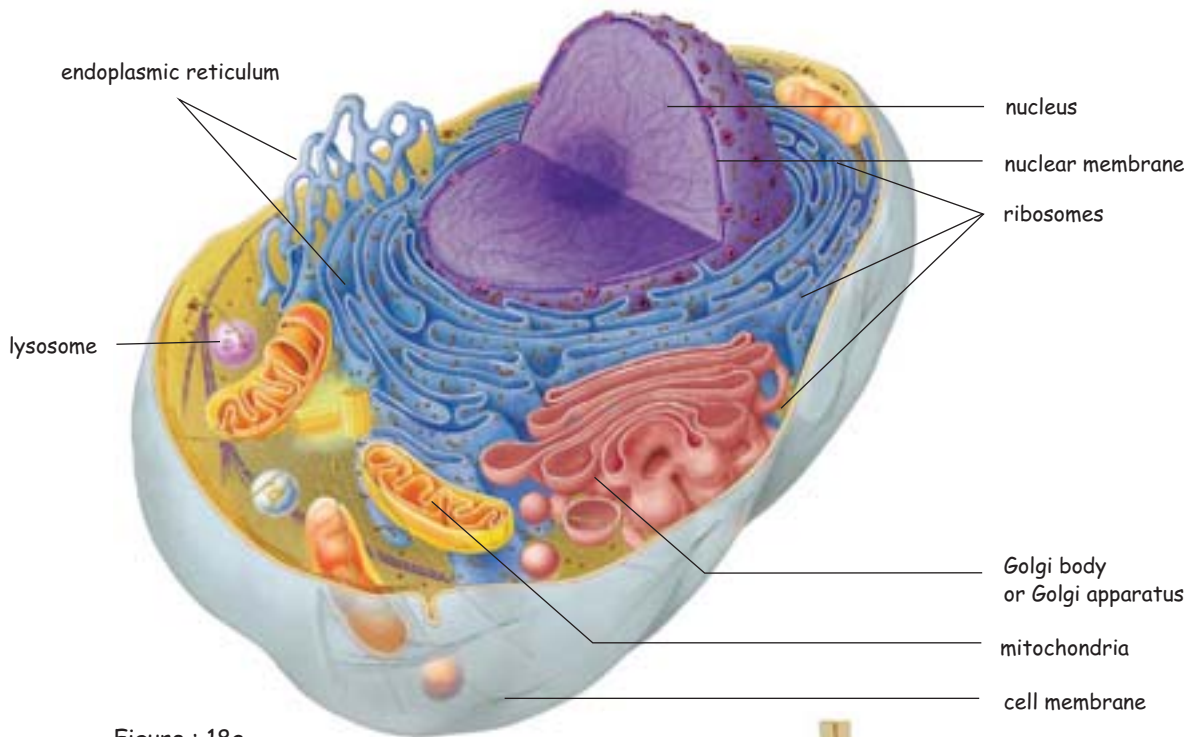

Figure : 18a
A typical animal cell;

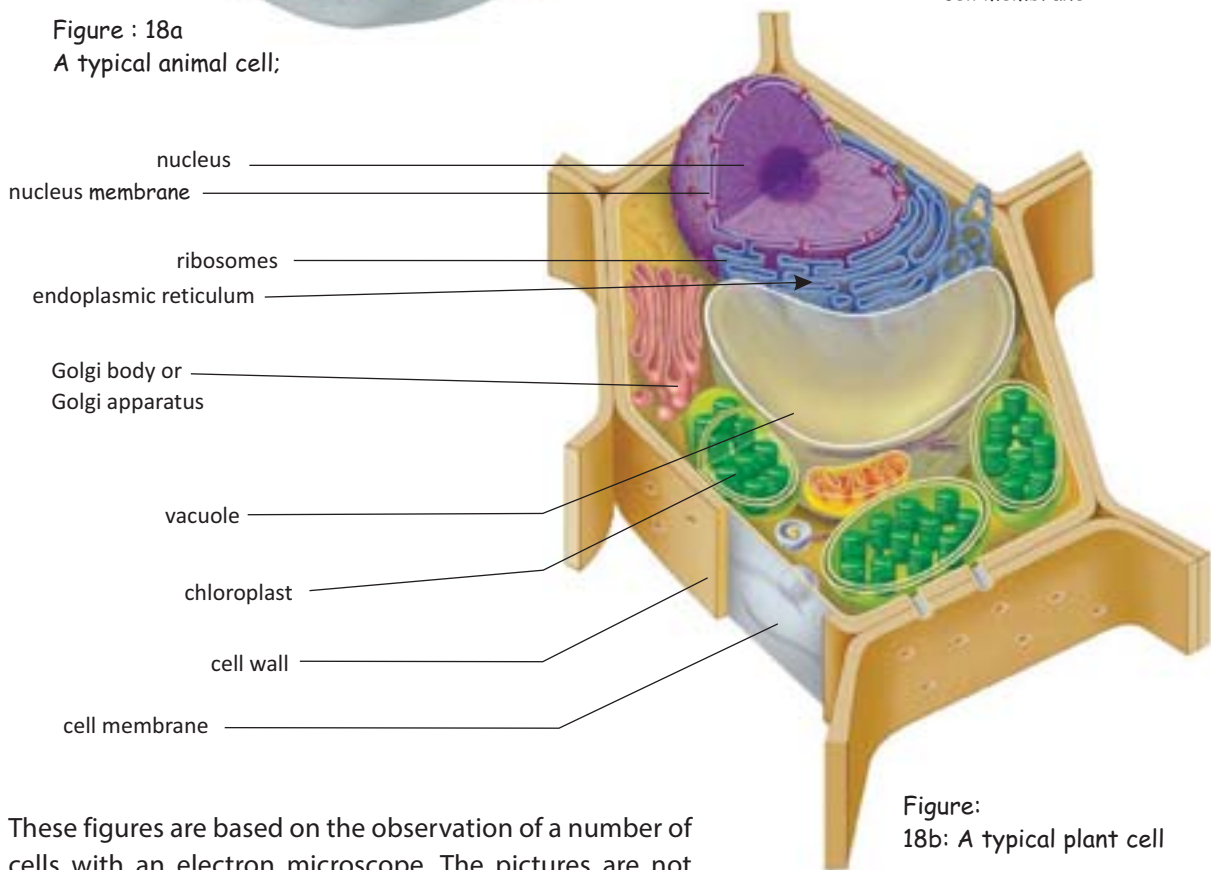

Figure:
18b: A typical plant cell

These figures are based on the observation of a number of cells with an electron microscope. The pictures are not drawn to scale. The figures basically depict the internal structure of organelles found in the cell.

Cell Membrane

The cell membrane is the outermost layer of the cell that separates cytoplasm from the external environment. This is also known as plasma membrane. It defines the shape and size of the cell, encloses the cytoplasm and protects it from the external environment. The internal environment of the cell is different from outside. Inside a cell, one finds a very specific composition and the balance of various substances is maintained constant. The cell membrane plays a crucial role in maintaining this balance.

Any substance entering or leaving the cell can do so only through this membrane. The uniqueness of this membrane lies in the fact that it does not allow each and every substance to pass through it. The exchange of substances through the cell membrane happens very selectively. Hence it is known as a selectively permeable membrane. This characteristic of the membrane enables it to control the exchange of substances.

Incidentally, the cell membrane has another function as well. The cell membrane has specific identifying markers or labels that help the cells to recognize each other. In other words, establishing the cell's identity is also the responsibility of its membrane. This function of the membrane is immensely important. In the initial phase of development in animals new cells are created and transported to other parts of the body. Then, the new cells are identified at their final position by these markers on the membrane. This affinity created between the cells plays a significant role in the development of tissues and organs. Moreover, if a foreign cell enters the body, the body's own cells are able to recognize it as an alien body.



Figure 19 :
Cells of a boiled potato as seen under the scanning electron microscope (magnification unknown)

cell wall

While the plasma membrane acts as the outer layer in an animal cell, in a plant cell there is a strong layer of cellulose outside the cell membrane which is known as the cell wall. This is a unique feature of plant cells and is considered one of the major differences between plant and animal cells.

The cell wall is a rigid or flexible porous layer that lends a definite shape to the cell and it also provides protection. Earlier it was believed to be an inactive wall, but it is now considered to be an important organelle of the cell that continuously exchanges information with other cells during growth and development.



Figure 20:
Cells in a tomato peel X 450

Observing the cell membrane of the Rhoeo leaf

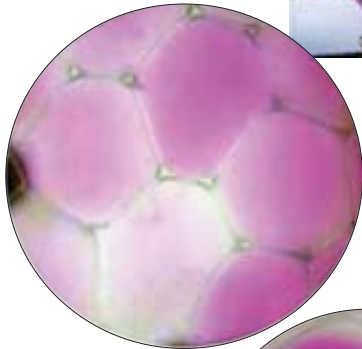
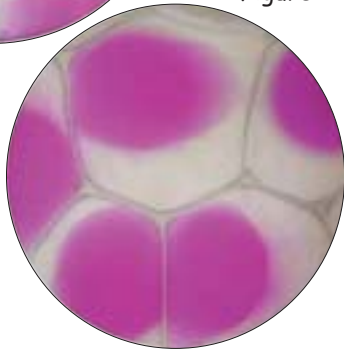

Figure 21a

Figure 21b



Activity 5: Observing the cell membrane

It is not possible to observe the cell membrane directly. We only get to know of its presence in an indirect manner. To do so, we need leaves of Rhoeo bicolour. It is an ornamental plant with leaves that are green on the upper surface and purple on the lower. Take a leaf from this plant and peel a membrane from the purple surface. Place it on a slide in a drop of water and observe it under a microscope (figure 21a).

Do you see the cells filled with a pink substance?

Now put 1-2 drops of dilute salt solution on the membrane and leave it for 5 minutes. Observe it under the microscope once again (figure 21b).

Do you see the pink substance shrunken into a portion of the cell?

What has happened is that the cytoplasm has shrunken together with the cell membrane because of the salt solution. The outer boundary of the coloured portion is actually the cell membrane which has separated from the cell wall. You can make the concentrated colour spread over the entire cell once again. For this you need to wash the membrane with water and leave it for some time (5 minutes).

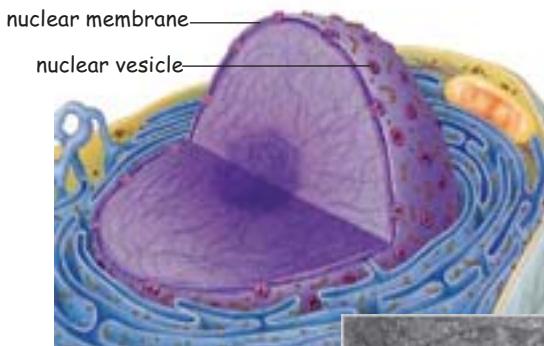

Image of a cut-out segment of a nucleus

Image 22



Image of the nucleus as seen under the scanning electron microscope

Nucleus

This is one of the most important organelles of the cell. This is also known as the cell's control room. The nucleus is the largest and most distinct of all cell organelles. Robert Brown named it in the year 1831, but he had no idea of its function. Schleiden, who was one of the proponents of cell theory, thought that new cells were created from the nucleus and he called it the cytoblast.

Barring a few exceptions, all eukaryotic cells have a nucleus. Red blood cells in some mammals and phloem sieve tube in plants are examples of cells that do not have a nucleus. Even these cells do have nuclei in the beginning, but it is later thrown out of the cells and destroyed.

The nucleus regulates and controls all cell functions and determines the characteristics of the organism. It is the bearer of all genetic information. The nucleus is also closely related to the process of cell division.

A membrane separates the nucleus from the cytoplasm. This is very similar to the cell membrane. There are a lot of pores in this membrane through which materials can be exchanged. Almost the entire genetic material of the cells, namely the DNA, is found in the nucleus. The DNA is combined with other substances to form chromatin which condenses during cell division in the form of chromosomes. Chemical units called genes in DNA determine what proteins can be produced in that particular cell. Genetic traits are determined by the proteins produced. The information needed to produce

proteins is carried from the nucleus into the cytoplasm in the form of another molecule known as RNA. Manufacture of proteins takes place in organelles known as ribosomes.

Ribosomes

Ribosomes are like tiny particles scattered throughout the cell. Mostly, they are found sticking on the surface of the endoplasmic reticulum. As mentioned above, the process of protein production occurs in these ribosomes based on the information received from the nucleus.

When the cell was observed under the electron microscope, a network of membranes was observed throughout the cytoplasm. This network creates passages within the cytoplasm for the transport of substances from one part of the cell to another. This network of membranes is known as the endoplasmic reticulum.

Figure 23: The information used to produce proteins reaches the ribosomes present on endoplasmic reticulum from the nucleus. Proteins are produced in the ribosomes and transported to the Golgi bodies in vesicles. The proteins get packaged in the Golgi bodies and are sent to the other parts of the cytoplasm or outside the cell.

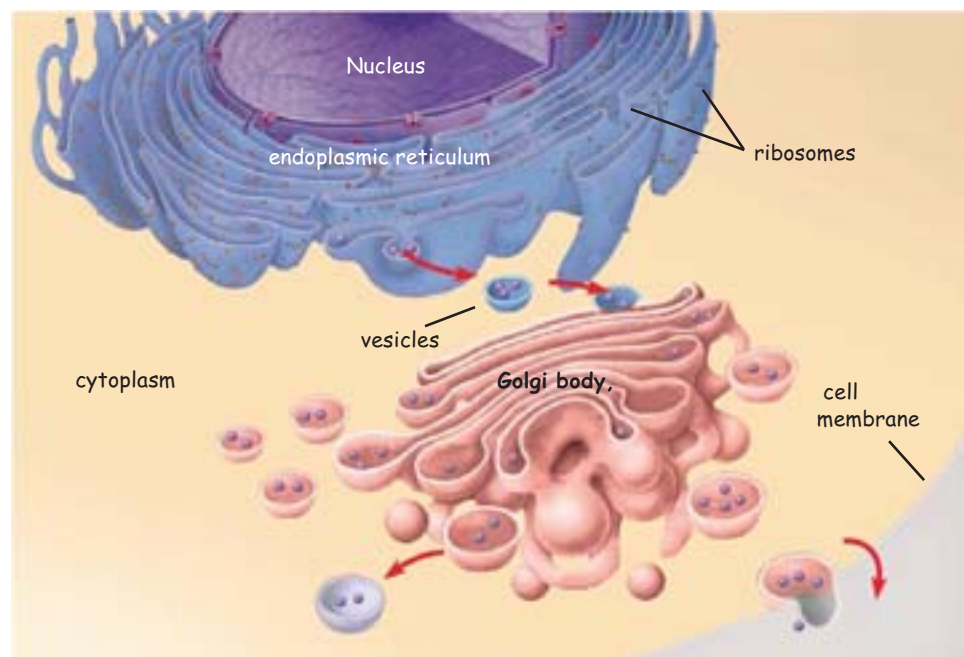

Experiments with Acetabularia

In 1934, a German biologist Joachim Hammerling proved, on the basis of experiments performed on a marine alga *Acetabularia*, that the characteristics of any organism are determined by its nucleus.

In his experiments, Hammerling took the base of a flower-capped *Acetabularia* (devoid of the stalk and the cap) and attached the stalk (devoid of the cap and the base) of an umbrella-capped alga to it. The cap that grew on this alga was a cross between the flower and the umbrella type. This meant that certain substances from the base and from the stalk together were responsible in determining the shape of the cap.

Hammerling then removed the cap from this hybrid alga. The cap that grew this time looked like a flower. In other words, its shape now totally depended on the base, that is, some substance generated by the base was deciding the shape of the cap.

Hammerling had already observed that the nucleus of the algal cell was present in its base.

Based on several such experiments, biologists concluded that the nucleus has the information to

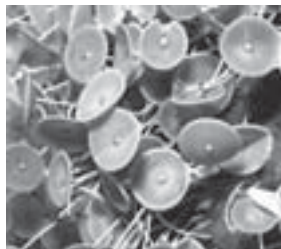

A. mediterranea



flower-cap alga *A. crenulata*

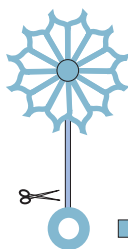
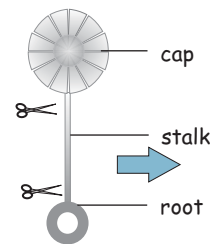

Acetabularia

This marine alga consists of a single cell. It is basically a long thread-like structure (approx. 6 cm.) that has three parts: base, stalk and cap. Different species of this alga have caps of different shapes. Some caps look like the inverted umbrellas while others look like flowers. If the caps are cut off, they grow again.

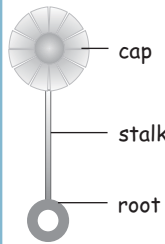

create all the different kinds of cells in the organism.

However, the next question was, how does the entire organism with so many different kinds of cells develop from a single cell? Offspring inherit the traits of their parents through a single cell, the zygote, from which they develop. This indicates that nucleus is also responsible for carrying the characteristics from one generation to the next.

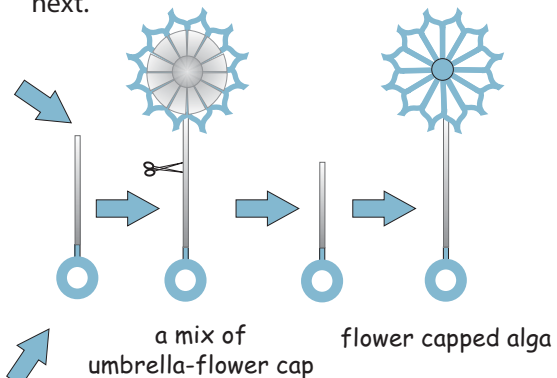
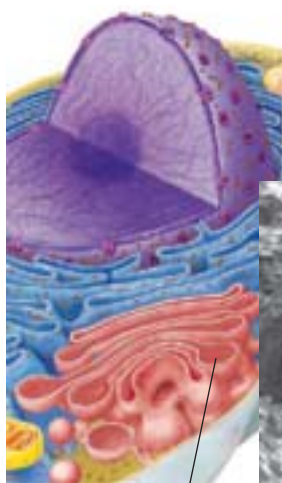

Figure 24

Golgi Body or Golgi Apparatus

Although Camillo Golgi had observed this organelle in the year 1898 using an optical microscope, its finer structure could be observed only under an electron microscope. This organelle is also made up of several membranes. These membranes create sac-like structures around which many fluid-filled vesicles abound. The proteins and other substances produced in the ribosome reach the Golgi body through these vesicles. Here, these substances are altered slightly. In a way, the function of the Golgi bodies is to package various substances before they are transported to other parts of the cell. From here these substances are either sent towards the cell membrane or to another organelle, the lysosome. After reaching the cell membrane these substances are either used to reconstruct the membrane or are secreted from the cell.

The number of Golgi bodies varies from cell to cell. Their numbers are particularly large in those cells that secrete hormones and enzymes.



Golgi body

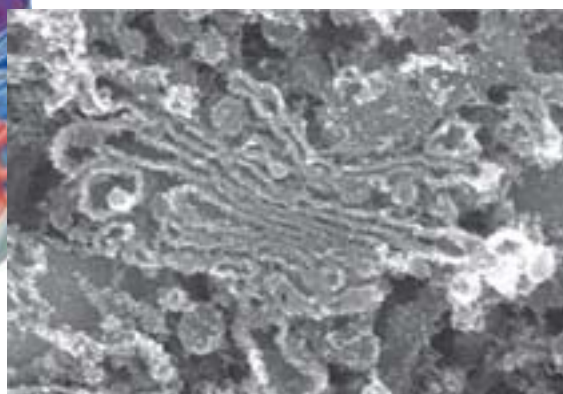

Lysosome

It was found that when a cell was ruptured and its material analyzed, it contained some enzymes that had the ability to destroy almost all the substances of the cell. The question which troubled the scientist was why these enzymes did not actually destroy the cell. This enigma was solved when lysosomes were discovered as tiny particles visible in the cytoplasm. It became clear that destructive enzymes are contained in the lysosomes and normally do not come in contact with the rest of the cell. The materials that need to be destroyed are transported to the lysosome. Occasionally, under special circumstances, the lysosomes burst open and the enzymes thus released digest the cell from within. Hence, lysosomes are also known as the suicidal bags of the cell.

Mitochondria

Mitochondria are small, spherical or cylindrical organelles. Generally a mitochondrion is 2-8 micron long and about 0.5 micron wide. It is about 150 times smaller than the nucleus. There are about 100-150 mitochondria in each cell. When seen under the optical microscope, the mitochondria appear as oval or cylindrical dots in

Image 25:
Image of the Golgi body as seen under the scanning electron microscope.
Figure 25: Image of the Golgi

Chloroplast

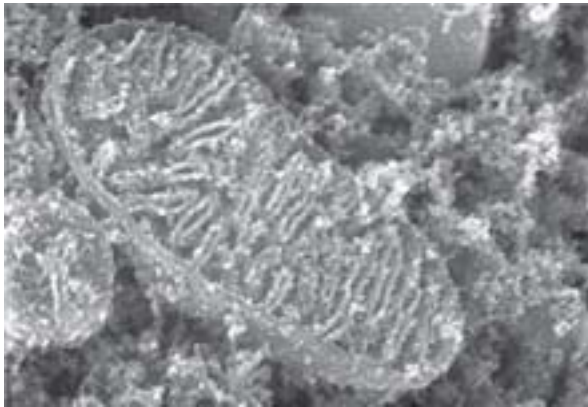
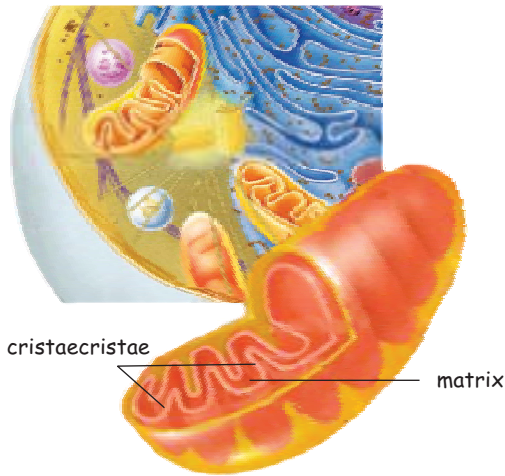

Figure 26: Image of a Mitochondrion as seen under transmission electron microscope

the cell. Electron microscope reveals their unique internal structure in great detail. The mitochondria often shown in the diagrams of typical cell can be deceptive because what is usually depicted is, in fact, the internal structure of the organelle as seen in a longitudinal section.

Information derived from the electron microscope shows that the mitochondria are made of a double-membrane. The inner membrane protrudes into the interior in folds and forms structures called cristae; the space between cristae is known as the matrix.

Mitochondria are responsible for cellular respiration, a process through which the cell derives its energy to do work. Because of this, mitochondria are also known as the cell's powerhouse.

This is one organelle not found in animal cells. Chloroplast is present in the mesophyll and palisade cells of the leaves. It is also present in the green stems of plants. In most cases, chloroplasts are disc-shaped, oval or lenticular. However, in algae, these can be found as ladders, stars, spirals or reticular.

The diameter of chloroplasts in higher plants can vary between 4 and 10 micron. The primary function of chloroplasts is to absorb the energy of sunlight and transform it into chemical energy. This process is called photosynthesis and it involves making carbohydrate by combining carbon dioxide and water.



Chloroplast in cells

Image 27

In fact, a chloroplast is a special kind of plastid, which is a common organelle found in plant cells. Other than chloroplasts, leucoplasts (white plastids) and chromoplast (coloured plastids) are also found in plant cells. Plastids are responsible for the colourful petals found in flowers.

Cytoskeleton

The cytoplasm which remains even after removing the above-mentioned organelles is also not a homogeneous fluid. A whole network of thin fibres and tubes extends from the cell membrane to the nucleus. These stabilise the structure of the cell and can be likened to the scaffolds that support a tent. This network of fibres and tubes is known as the cytoskeleton.

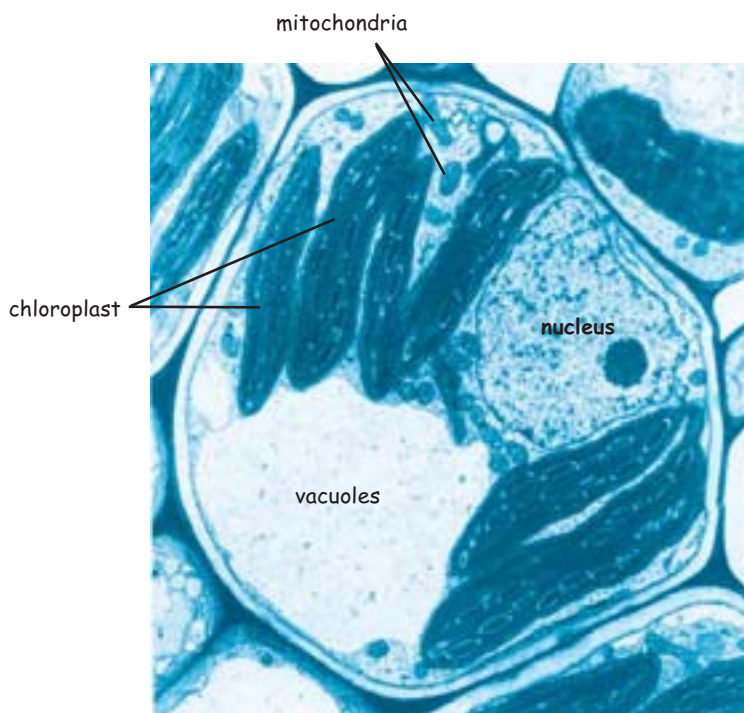

Figure 28:
Corn leaf cells as seen under transmission electron microscope;

Mitochondria and chloroplast

An interesting fact

Mitochondria and chloroplasts are special in the sense that both these organelles have their own DNA. This is apart from the DNA found in the nucleus. Besides this, there are other facts which led scientists to believe that perhaps at some point in history these two (i.e. mitochondria and chloroplast) were independent organisms that somehow became part of the eukaryotic cell.

Vacuoles

There are a few fluid-filled sac-like structures found in cells. These are called vacuoles. While vacuoles are quite small in animal cells, plant cells have large vacuoles and in mature plant cells they might occupy almost the entire space.

Specific substances are stored in these vacuoles. Vacuoles also regulate the osmotic pressure of the cytoplasm.

Prokaryotic Cells

The above description was primarily about eukaryotic cells. We have mentioned earlier that bacterium is a prokaryotic cell. Cyanobacteria (blue-green algae) too fall in this category.

Prokaryotic cells are also enclosed in a cell membrane and a cell wall. However, quite a few organelles are not found in these cells. As mentioned earlier, prokaryotic

Figure 29a:
Torch cactus plant

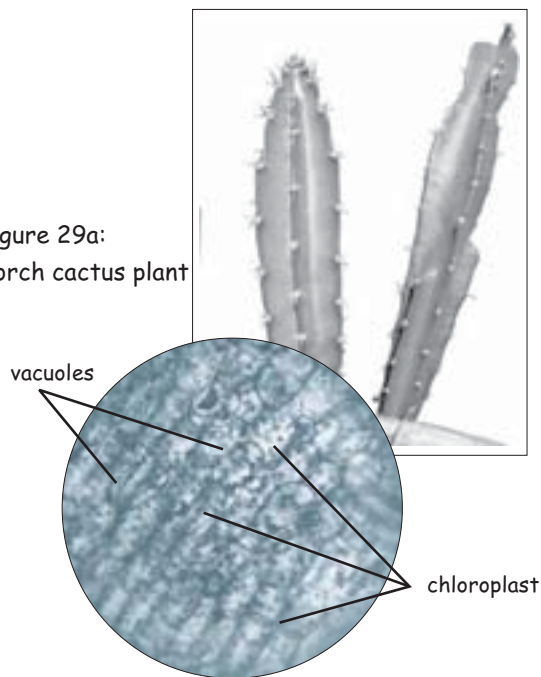

29b: cross section of the stem
of torch cactus as seen under
the microscope X100

Activity 6: Observing vacuoles

It is a bit difficult to observe vacuoles since they are almost transparent. However, they can be seen in the leaves or stem of any succulent plant (like the torch cactus).

The picture given here will help you to identify the torch cactus. Take a thin cross-section of its stem and stain it with dilute saffranin solution. Now observe the section under low as well as high magnification. The large empty spaces visible in the cells are vacuoles.

You will also see many yellowish-green chloroplasts in these cells.

cells do not have a nuclear membrane and thus they lack a well defined nucleus. In fact, most cell organelles found in eukaryotic cells are not found in prokaryotic cells. For example, the mitochondria, the endoplasmic reticulum and the Golgi apparatus are absent in prokaryotic cells. The prokaryotic cells do not have a cytoskeleton



Image of a prokaryotic cell (E.Coli) as seen
under an electron microscope

either. Nevertheless, they have ribosomes. Chlorophyll is also found in photosynthetic bacteria, though not organized inside chloroplasts.

The fact that these cells do not have a nucleus does not mean that they lack DNA as well. The only difference is that DNA exists as a circular structure in prokaryotic cells.

Since prokaryotic cells lack many organelles, most functions associated with these organelles take place in the cytoplasm itself. A few functions are carried out on the inner surface of the cell membrane. For example, most of the functions of the mitochondria occur on the inner surface of the cell membrane.

So this was a brief account of a typical cell. While reading this you need to keep a few things in mind. Firstly, the internal structure of the cell is

Comparison between the prokaryotic and eukaryotic cells

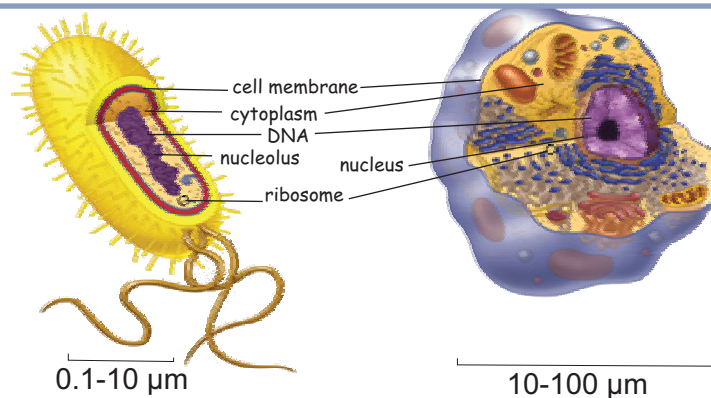

Characteristics	Prokaryotic Cell	Eukaryotic Cell
Size	0.1-10 micrometer	10-100 micrometer
nuclear membrane	absent	present
chromosome	one, circular	many, linear
Golgi body	absent	present
endoplasmic reticulum	absent	present
Mitochondria	absent	present
chlorophyll	Not contained in chloroplast	Contained in chloroplast
ribosome	comparatively smaller	comparatively bigger
cytoskeleton	absent	present

not static. All the pictures of cells given here or the ones that you would encounter elsewhere, depict the cell as it appears at that precise moment when they were observed. We call these snapshots. The cytoskeleton and the endoplasmic reticulum are constantly destroyed and recreated. Even other organelles are neither stationary at a particular location nor do they exist permanently in the cell. The cell is not an inanimate object. It has internal dynamics of its own. The manner in which we prepare the material for observation affects the internal structure of the cell and normally we get to observe only dead cells.

The second thing is that the diagram of a cell usually shows one Golgi body, few mitochondria and one or two chloroplasts. In reality, the numbers of these organelles depends on the nature of the cell. For instance, cells primarily

responsible for secretion of hormones and enzymes may contain 5-6 Golgi bodies. Some cells have a large number of mitochondria. Similarly, cells in the green parts of plants may contain up to 40-50 chloroplasts.

The third thing is that in pictures and diagrams, the cell appears to be flat. In reality, cells are three dimensional structures that also have depth in addition to length and breadth. When we observe any object under the microscope we usually see a thin section of that object. When the material is brought into focus in the microscope, we only see one layer of cells. Hence it's quite natural to perceive the cell as flat. Nowadays, some books have started presenting three-dimensional pictures of cells. A few activities have been suggested to clarify this aspect in Appendix 3.

Where do cells come from?

While observation under microscopes opened a whole new field of the study of cells, it also added a new dimension to an age-old controversy. The story of cells will remain unfinished if we do not talk about this debate. It is related to the formation of new cells.



Earlier, we had mentioned that Anthony van Leeuwenhoek was among the many scientists who used microscopes to observe cells. Leeuwenhoek was a contemporary of Robert Hooke. Although a cloth merchant, Leeuwenhoek seemed to have made the observation of objects under the microscope a major occupation in life. He used to examine living organisms or the products of living organisms and send reports of his observations to an organisation called the Royal Society of London. These reports used to get published in the Society's journal. This went on for 50 years. It is generally believed that the microscopes built by Leeuwenhoek were of excellent quality and

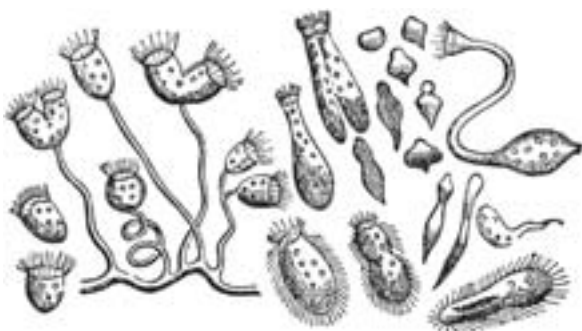

Figure 30:
A leaf from Leeuwenhoek's book

that he had acquired immense expertise in grinding lenses, but unfortunately, he did not leave behind any records of his methods.

Leeuwenhoek observed many microscopic organisms with his microscope and called these "animalcules". His observations reached their zenith when in 1683 he saw a bacterium. We will

Activity 7a: Observing a drop of water

Get some water from a puddle or a pond in a beaker. It would be good to collect algae, other vegetation and debris found in the puddle or pond along with the water.

Place 1-2 drops of this water on a slide along with the debris in the water sample, cover it with a cover slip and observe it under the microscope. Observe all portions of the slide. Look at the areas surrounding the debris in particular. With patience, a number of organisms can be observed.

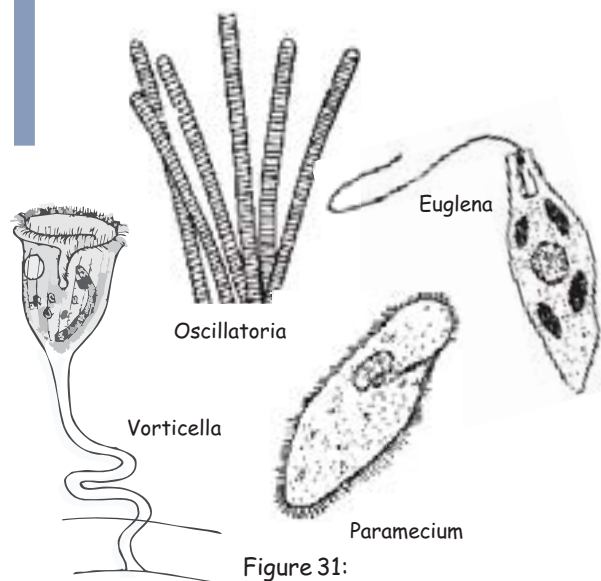

Figure 31:
Line drawing of a few of the organisms normally observed in the puddle water;

Were you and your students able to see some micro-organisms moving about in the water?

It would be great if the students make drawings of these organisms and describe their movements in their own words.

talk about the controversies generated by these observations later. Let us first observe the organisms that Leeuwenhoek might have seen.

While observing these organisms, do keep one thing in mind. In most cases while we observe, we think of the pictures that we usually see in books. But in reality, the organisms do not look like that. It is because the organisms make movements and also because the pictures in books are generalised figures of these organisms.

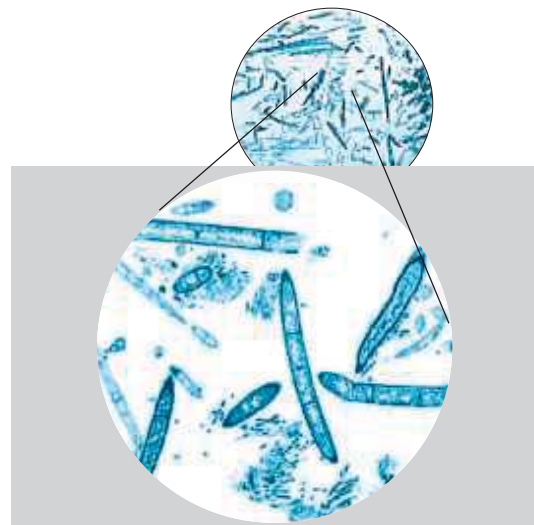

Picture of a drop of puddle water as seen under the microscope

Activity 7b: Yeast cells

We use yeast to prepare a lot of dishes, for example, jalebi, bread and alcohol. Get some jalebi-making batter from any sweet shop. Make a dilute solution of this dough in water. The solution has to be dilute enough to be slightly turbid. Leave it standing for sometime. After the flour settles to the bottom of the container, place a few drops of the supernatant solution on a slide, cover it with a cover slip and observe it under the microscope. By the way, yeast powder is available in the market and this can also be used. Take a few grains of the commercial yeast and place it in a dilute sugar solution and observe after a couple of hours.

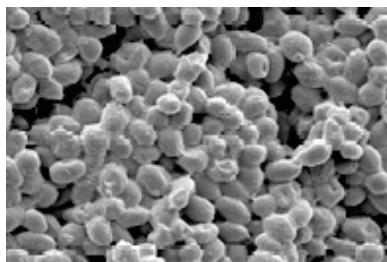

Figure 33
Yeast cells as seen under the electron microscope

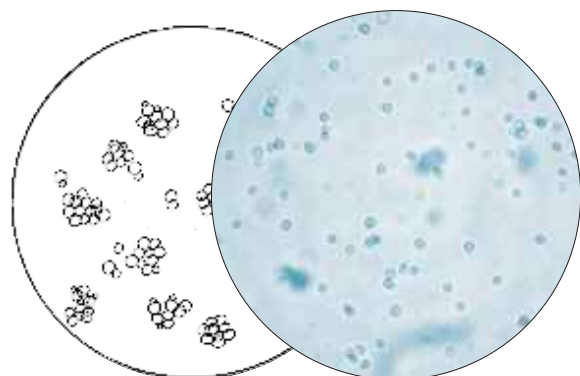

Figure 32 yeast cells as seen under the optical microscope X400

Were you able to see a lot of small oval structures?

These are the yeast cells. This is a unicellular organism (made of a single cell).

Draw the cells you see.

Activity 7c: Cells in curd (yogurt)

Take some curd. Mix it with water and make a dilute solution. Put 1-2 drops of this solution on a slide, cover it with a cover slip and examine it under the microscope under high magnification. Do refer to the proper procedure for observing objects under high magnification given in Appendix 1.

Were you able to see oval or cylindrical structures in the solution?

These are bacteria.

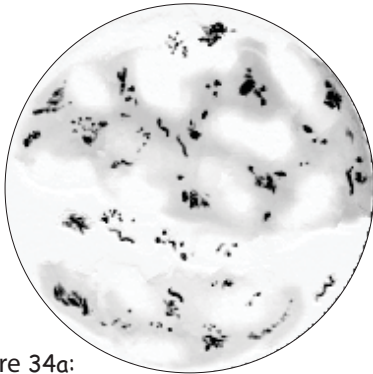

Figure 34a:
Bacteria in curd X 1000

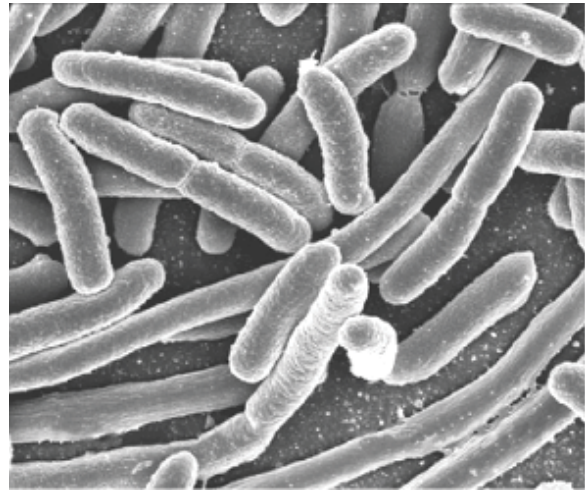

Figure 34b:
Image of curd bacteria cells as seen
under the electron microscope

Micro-organisms raise a major question

You must have noticed that if you observe drops of water from a puddle under the microscope, you see micro-organisms in it. Where did these come from? This has been a major question in the Life Sciences: where do living organisms come from? One of the theories was that organisms are born spontaneously from inanimate materials. The idea seemed quite natural. Even during the 19th century, people believed in Aristotle's (384–322 BC) idea that there are certain qualities in water and the soil that can transform inanimate substances to living beings. This is known as spontaneous generation. Even today

many people believe that frogs are born from muck or flies are created in cow dung or lice crop up in sweat.

It may be useful to discuss this with your students and get an idea of what they think about this or if they have heard anything like this. If you think it necessary, you could also conduct the experiments that Francesco Redi (1626–1697) had done to prove that living beings are generated only from other living beings. If you'd like to do it, a revised version of the experiment is given below.

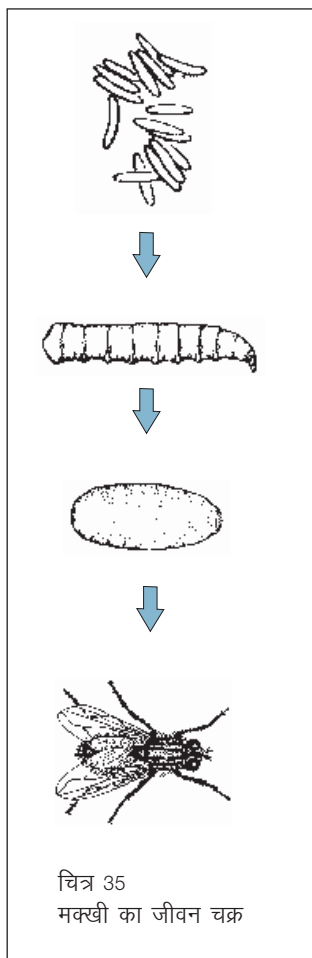
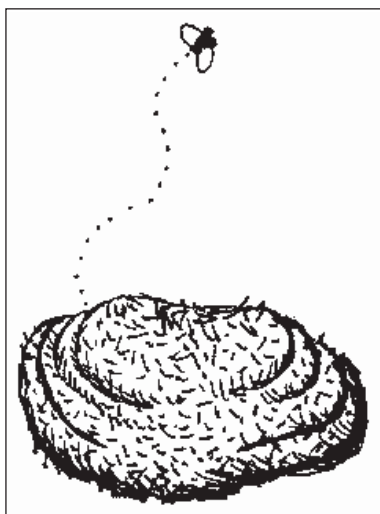

Activity 8: Lifecycle of a fly

Through his experiments with the housefly, Redi was able to prove that living beings can only be born from other similar living organisms and not from inanimate materials. Incidentally, this experiment gave birth to a new concept in the field of experiments, viz., provision of a control.

Redi's experiment can be done in the following manner. It is best to do this experiment during the monsoons. Take two tin cans or plastic glasses. Write "A" on one and "B" on the other. The next step has to be done quite carefully. Take some fresh cow dung before any fly can sit on it and put equal quantities of this dung in the two containers. Cover the mouth of can "A" with a plastic sheet and make a few tiny holes in it so that air can pass through but not flies or any other animals.

Leave the mouth of container "B" open and let flies sit on the dung inside. Flies will definitely arrive if you leave the dung uncovered for about 1-2 hours. A wonderful observation can be made when a fly sits on the dung. Look at the rear end of the fly's body and you will see white objects coming out. These are the fly's eggs.

By the way, there is another method of obtaining these eggs. You could try to locate the eggs on dung which is not so freshly laid. Flies usually lay eggs between the folds or layers of the dung. If you poke and scratch the dung a little bit, you'll find lots of eggs. Take a bunch of these eggs with some dung and put it on the dung in container "B". Now cover the mouth of this can also with a plastic sheet and make tiny holes in the sheet.

Every day you would need to open the plastic covers, observe the eggs and keep track of any changes that take place. When you open the containers, make sure that more flies do not sit on the dung. You would also need to add a few drops of water to the dung each day so that it does not dry up. Keep track of the number of days for the



1677 में बना फ्रांसेस्को रेडी का यादगार पदक

following events to occur: larvae (maggots) to appear, maggots becoming inactive and slowly transforming into pupae and the pupa finally becoming a fly.

The main thing to notice is whether maggot, pupa and the flies are produced in both the containers or in only one of them.

It was based on a similar experiment that Redi concluded that flies are only produced if fly's eggs are already present in the container. In other words, any organisms can be formed only if similar beings already exist. By the way, for this experiment Redi did not use cow dung; he used meat instead.

Redi's experiment had convinced many people that living beings are produced only from pre-existing living organisms. However, the observation of micro-organisms once again brought forth the same old question. People began to feel that perhaps these tiny organisms actually came into existence through spontaneous generation.

So is spontaneous generation possible?

Once the cell was discovered and cell theory was propounded, the same question came to the fore in a different form — living beings have many cells, where do all these cells come from? Or, to be precise, where do cells per se come from? Do reflect on the significance of this question. It is obvious that the materials like nitrogen, carbon, oxygen etc. which make up the organisms are non-living. Now, if these substances do not have life's characteristics, then what is special about the living beings that make these same inanimate substances behave in a different manner? The same thing could be expressed by saying that the characteristic of life lies not in these substances but in their arrangement, their organization. Cell theory thus underscores the fact that cell is the smallest unit of such a living organisation of inanimate substances.

It would be good to pause for a while and ask the students what they think about this: where do cells or micro-organisms come from. It is important for you to be really open-minded and allow them to let their imaginations run wild, because in the 19th century the scientists too gave free rein to their ideas. Evidently, even the wildest ideas do have some basis. For example, people believed that micro-organisms were generated spontaneously from water or soil. They had observed that micro-organisms grew on nutrient mediums like meat if they were left open for some time. Some people thought that these organisms formed on their own. Indeed, they felt that these micro-organisms were a bridge between the living and the non-living. Louis Pasteur (1822-1895), demolished this belief with just a few simple and elegant experiments (see box "Pasteur's experiment").

Pasteur's experiment



Observation

Meat broth was made micro-organism free and kept in a glass flask.

After some time, micro-organisms were found again in the broth.

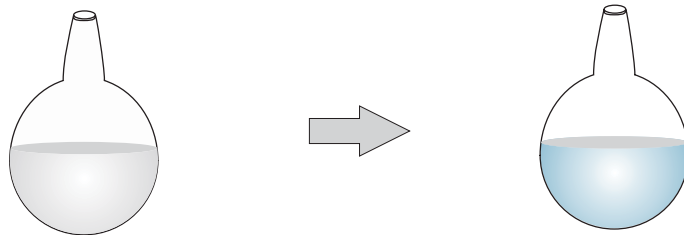

Question

How did the micro-organism come into the meat broth?

hypothesis

- The organisms were produced from the inanimate broth itself.
- The organisms came from outside.

Experi

Pasteur took two flasks with a nutrient medium in which micro-organisms could flourish. The neck of one flask was kept straight while the other was bent as shown in the diagram. Then he heated these containers so that all the micro-organisms were

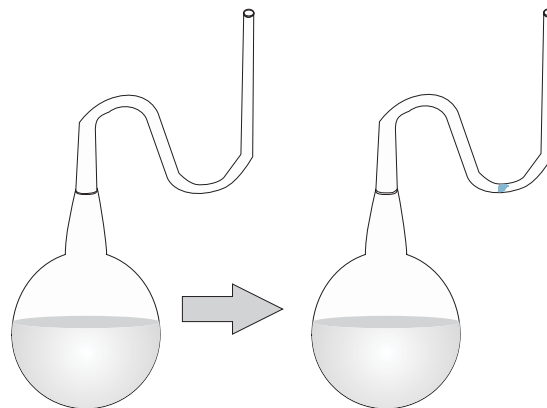

सूक्ष्म जीव नहीं पाए गए

killed. Now he left these containers for a few days without disturbing them.

Few days later, when he examined these flasks, he found that the flask with the straight neck was full of micro-organisms while the other one with a bent neck did not have a single micro-organism in it.

Conclusion

If the micro-organisms were automatically generated from the broth then they should have appeared in both the flasks. But that did not happen. Pasteur concluded that micro-organisms present in the air entered the straight necked flask and proliferated in the broth. In the other flask, the micro-organisms were trapped at the bend in the neck and hence no micro-organisms were found in this flask.

Experiment

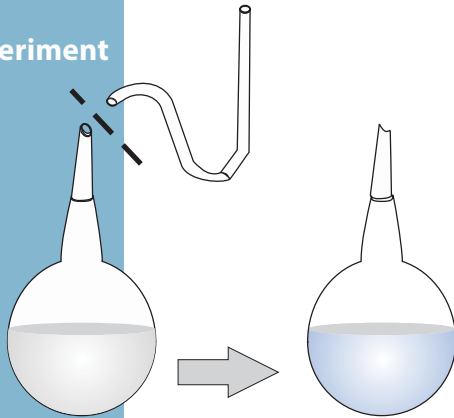

सूक्ष्मजीव फिर से पाए गए

Conclusion

It was found that unless dust particles enter the flask, no micro-organisms are found in it. Hence hypothesis (a) is false and hypothesis (b) is true.

When this did not satisfy the critics, Pasteur did one more thing. He broke the bent neck and after a few days, micro-organisms were seen to proliferate in this flask as well.

If the cell is indeed the smallest unit of life, the question arises - where do they come from? By this time it had already been discovered that the sperm as well the ovum are both single cells. The zygote that is created after the fertilisation is also a single cell. So how does this single cell produce the organism's entire body? You will remember that in the initial phase of cell theory, Schwann had stated, "there is one universal principle of development of the elementary parts of organisms... and this principle is the formation of cells." But he did not know how cells were actually produced. He felt that cells were formed in the same manner as crystals were formed.

We do not know what children think about this. Particularly, what ideas do they form about this after being introduced to cells? It will be useful to find this out before proceeding further. Moreover, in order to give a concrete basis to the discussion, it is important that they observe a single cell developing into a full-grown organism. Studying the life-cycle of frog will be very useful for this purpose.



We saw a whole lot of bacterial cells in curd. Actually, it is because of these bacterial cells that milk is transformed into curd. When we add some curd (culture) to milk, it contains a few bacteria that multiply in the milk. This process generates substances that are responsible for turning milk into curd.

Lifecycle of a frog

This experiment has to be done during the rainy season as frog spawn is available only in this season. These eggs are found massed together near the edge of rainwater puddles or around plants growing in ponds. The frog eggs are held together by a jelly-like substance. The given diagram depicts a rainwater puddle with frog eggs drawn to scale.

It would be easy to get eggs after 1-2 heavy spells of rain when the ditches are filled with water. Collect the eggs in a wide-mouthed bottle or a bucket along with the water in which the eggs were found. And make sure the spawn doesn't get disturbed. Try to get some algae and other debris from the puddle as well.

Figure 36a:
Eggs of frogs



After coming back to the school, keep the eggs in a wide-mouthed container (for example, a broken earthen pitcher/matka) along with the water from the same puddle or pond. Also put in the algae collected from the same puddle.

Now watch the eggs carefully. The structure visible inside the transparent, jelly-like substance is the embryo of the frog. This embryo is made of only a few cells.

This experiment will go on for 20-30 days. If the water in the pot reduces, you would need to keep filling it with water from the same puddle or pond. Once the experiment is set, the children will be able to observe the changes in the eggs taking place each day. It would be really interesting for the child to observe when exactly the tadpoles hatch out, whether these look like frogs, how the tadpoles develop further, when each organ develops and finally when an adult frog appears.

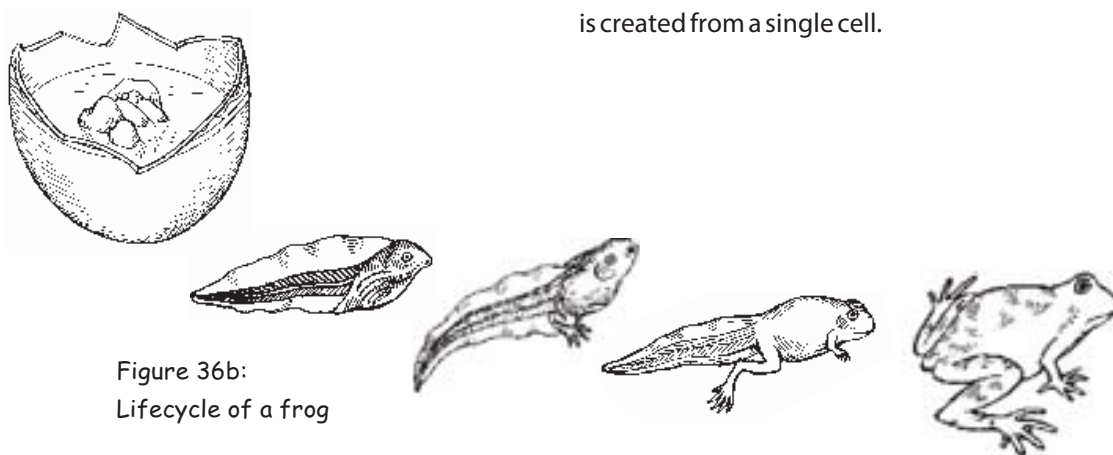

Figure 36b:
Lifecycle of a frog

To observe the tadpoles, it would be better to take out a single tadpole along with some water with a dropper. This tadpole can then be placed in a beaker or some other transparent container and observed using a hand lens. Every day, when the children observe the tadpole, direct their attention to the formation of new organs. They will see the gradual development of the eyes, gills, heart, intestines, backbone, and the front and hind legs of the frog. The tadpole is quite transparent and hence it is easy to observe its internal organs. Bring to the notice of the students that these organs have developed from a single embryonic cell.

Make a small mound with tiny pebbles in the pot so that the frog can climb on it once its hind legs appear. The development cycle of the frog will be completed the day it loses its tail completely.

Witnessing the lifecycle of the frog unfolding before them, students will realise the rationale behind the statement that cell is the unit of life. The creation of an entire frog from one single cell is actually the wonderful feat of the cell itself. Here two things have happened — one, a single fertilised cell has given rise to innumerable cells; and two, all the different types of cells in the body of the adult frog have been created from that single cell. Once children observe this happening, they would be in a better position to appreciate the question: how an entire organism is created from a single cell.

Cellula e cellula

Gradually it became clear that the development of living organisms is synonymous with formation of new cells. The theory of spontaneous generation had already been refuted. Hence it was necessary to explain how new cells are formed.

During the 19th century, when this question arose before the proponents of the cell theory, Schleiden put forth an idea. He was of the opinion that, there is some substance within the cell that precipitates as a sediment and takes the shape of a ball — he called it cytoblast, which was in reality the nucleus. He felt that this cytoblast slowly develops into a cell and comes out. For this reason, Schleiden considered the nucleus as the most significant organelle of the cell.

Few other scientists believed that cells formed bud-like structures from which new cells originated. One of the possible reasons for believing this could be that a few organisms indeed procreate by budding. We will also observe this in the pages ahead.

The study of the internal structure of the nucleus has been quite significant in understanding the way new cells are created. Similar to the manner in which people came to realise that the cytoplasm was not homogeneous, other staining techniques made it clear that the material inside the nucleus was also not homogeneous. Two scientists played a major role in using staining techniques to identify certain structures in the nucleus.

One among them was Eduard Adolf Strasburger (1844-1912). He was the first to use the technique of staining to observe the nucleus. Walther Flemming (1843-1905) too used the same technique to study the nucleus. Strasburger discovered a dye that could stain the substance



Chromosome in cell as seen under the electron microscope

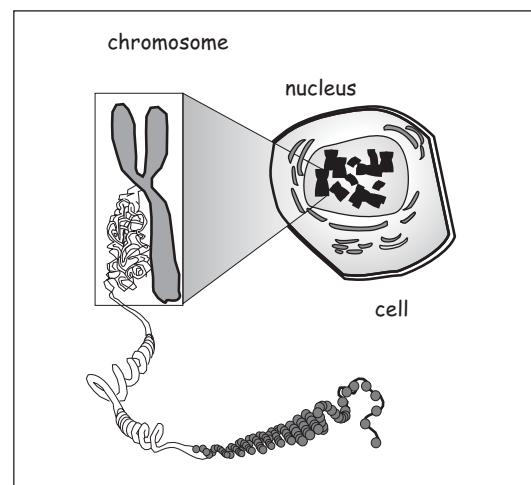

contained in the nucleus. He then stained a growing tissue with this and fixed it. To fix a cell, certain chemicals are used. When the cells are fixed, they die maintaining their structure as it was at the time of fixing. He observed the fixed cells and saw some thread-like structures in the cells that were dividing into two strands. The dye that he used imparted a deep colour to these

threads. He called these threads chromosomes. He examined different cells and was able to make a sequential diagram on the basis of these observations which showed that the cells were dividing.

Gradually it became clear that the cell divide. In 1882, Flemming was able to show that the chromosomes split vertically during cell division in salamanders, and that each half went to opposite ends of the cell.

In the succeeding years, the same phenomenon was observed in plant cells as well. Such studies established that new cells are produced by the division of existing cells. The credit of unambiguously stating that every kind of cell can only be created from an already existing cell – *omnis cellula e cellula* – goes to Rudolph Virchow. This Latin phrase means, “each cell is made from pre-existing cell”. This is another significant juncture in the development of the cell theory.

Thus, owing to the efforts of Schleiden, Schwann, Virchow among others, the following points of the cell theory had emerged by the year 1858:

- i. **All living organisms are made of one or more cells.**
- ii. **Cell is the fundamental living unit of organisms. It is the structural and functional unit of life.**
- iii. **All cells are created from the pre-existing cells.**

Let us also observe the process of cell division.

Activity 10: Budding in yeasts

Children have already seen the slides of yeast cells. Observe those cells once again under high magnification. This time try to locate those cells in particular that have another small oval cell glued onto them. These yeast cells are undergoing division.

As has been mentioned earlier, this process is known as budding. In this process, a protuberance appears on the cell which separates from the original cell after some time and becomes an independent organism.



Figure 37a:
yeast cells
X 400

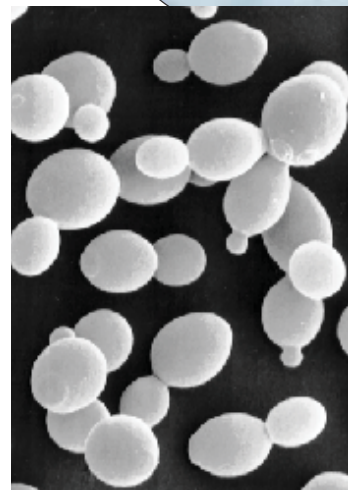

Figure 37b: budding in yeast cells
as seen under the electron
microscope

Activity 11: Cell division in onion roots



To make aceto-alcohol solution, mix 1 part of glacial acetic acid with 3 parts of alcohol.

Fill a wide-mouthed bottle with water till the brim. Take a medium-sized onion bulb and peel off 1-2 layers from it. Cut off the older dried root tips from the bottom of the bulb with a blade. Now keep the onion in the bottle in such a way that it just touches the water inside. Change the water in the bottle daily. After 3-4 days, a lot of roots would have grown from the base of the onion. We will use the tips of these roots to study cell division.

This solution will enter the cells and fix it so that division is stopped leaving the cells frozen in different stages of the process of division which we can then observe.

This solution will enter the cells and immediately stop their division and leave the cells as they are. As a result, we will be able to see the cells in their different stages of division.

Now heat the watch glass (at about 60° C) and leave it for about 10-15 minutes. Do not forget to put a lid on the watch glass.

In a watch glass mix aceto-carmine and 1N hydrochloric acid in a 9:1 ratio (that is, mix 9 drops of aceto-carmine with 1 drop of 1N hydrochloric acid).

Put a drop of aceto-carmine and acid mixture on a slide and place a root-tip in it with a pair of forceps.

You will notice that the distal part of the root tip has become deep red in colour; this is the portion where the cells are dividing. Hence, hold the cut end with the forceps while picking the root tips and be careful not to damage the distal part as this is what we are going to study.



Now with the help of a blade or a needle, cut the deep-red portion of the root (about 1 mm.).



Cover this 1mm. long root tip with a clean cover slip.



Warm the slide lightly.



Place the slide on a blotting paper and wrap the blotting paper over the slide. Tap the blotting paper over the cover slip lightly with the broad end of the pencil so that the root tip is crushed, and the cells are spread in an even layer under the coverslip.



Now our slide is ready for observation.

Observe the slide first under low and then under high magnification. Examine each part and try to locate the different stages of cell division.

What we need to observe is whether the nucleus is visible in all the cells. What structures are seen in those cells where the nucleus is not visible?

Here is an image (figure 38) that will help you with your observations. With its help try to see whether your slide shows cells where the nucleus appears quite large, whether there are thread-like structures in a few nuclei and whether there are two nuclei in a few other cells. These are the different stages of cell division. You would need to spend some time patiently observing all portions of the slide to see this, but slowly you will be able to visualise a complete picture of the entire process. The following figure (figure 39) depicts the various stages of cell division in a sequential manner.

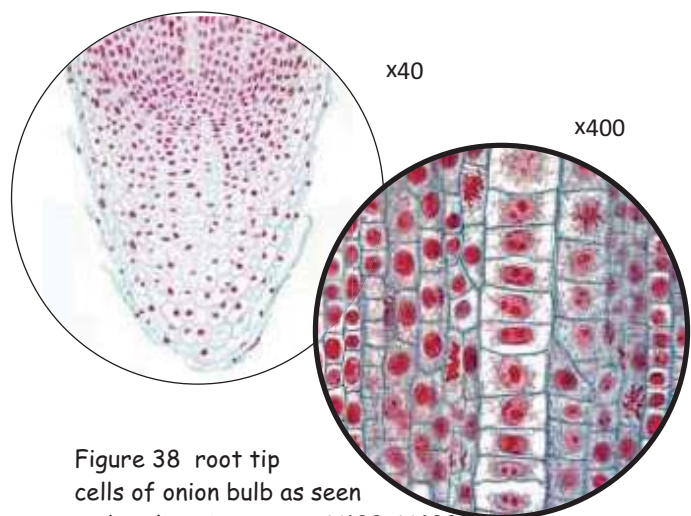

Figure 38 root tip cells of onion bulb as seen under the microscope; X100; X400

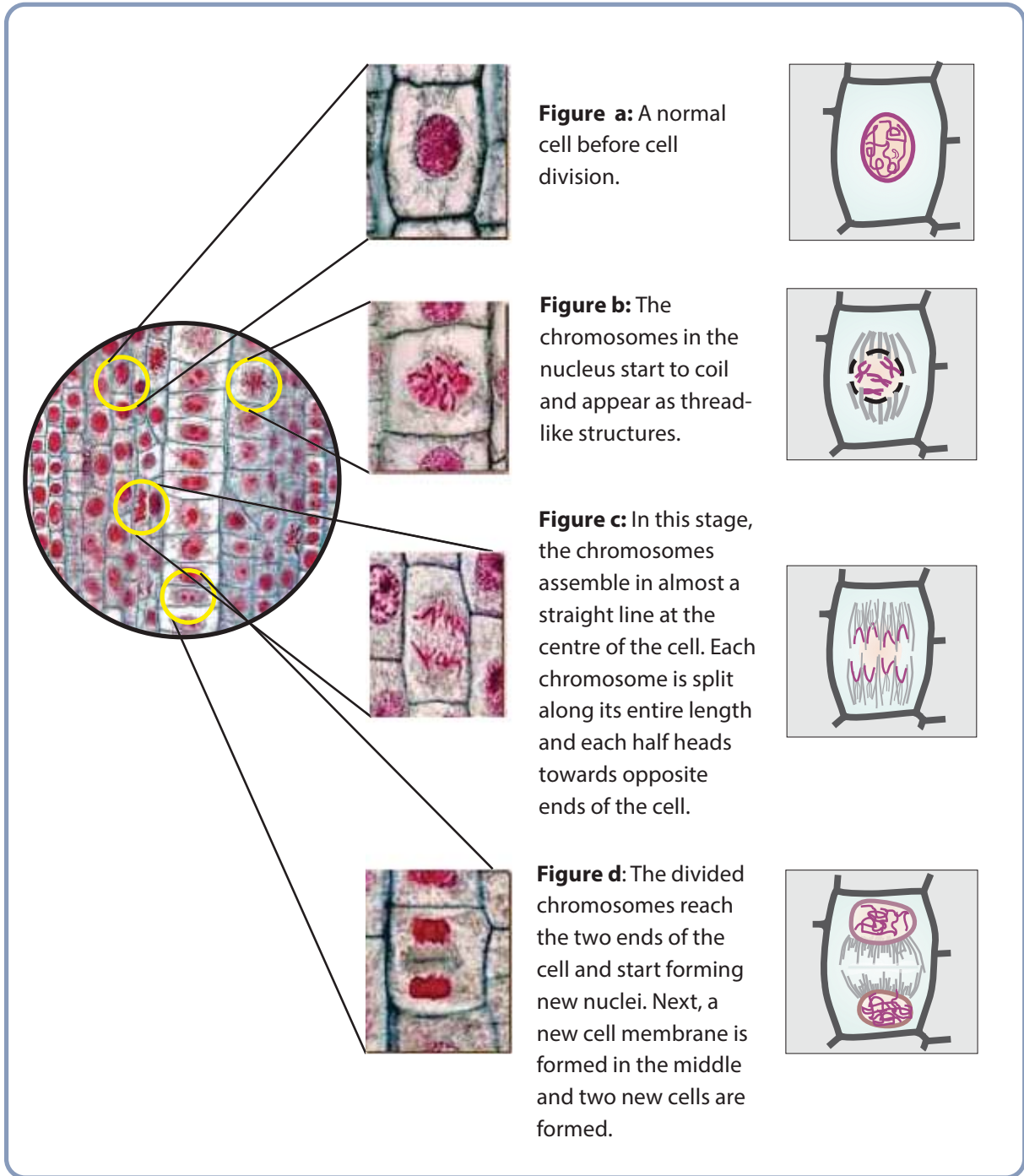
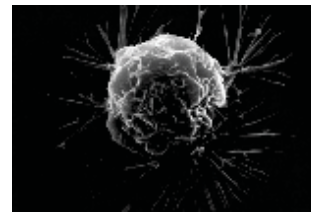

Figure 39:
Cell division in root cells of an onion bulb

Advancing cell theory

All these studies led to a massive progress in the cell theory. Today we know a lot in this area: the different organelles found in the cell, how they communicate with each other, how the functioning of the cells and organelles is controlled, and how the process of cell division is regulated. Similarly, the relation between heredity and the cell theory has also been discovered. In other words, the role of the cell in transferring the traits of one generation to the next has become clear. Studies are on to understand the manner in which one cell differentiates into different kinds of cells, because, after all a multi-cellular organism begins its life as a single cell and ends up having a variety of cells in its body. You must have heard about stem cells also. The study of stem cells have added new dimension to the treatment of some diseases.

Cell division is a tightly regulated process. In fact it is just one part of the entire cellular cycle. The cells in multi-cellular organisms are somehow programmed to undergo division a definite number of times. After this, the cell dies automatically. If a cell keeps on dividing in an unregulated manner, then that is not a good sign. Such a cell may take the form of cancer. At present, the facts are still not clear as to how the cell-cycle is regulated and why cells continue multiplying in certain cases.



cancer cells Stem Cells

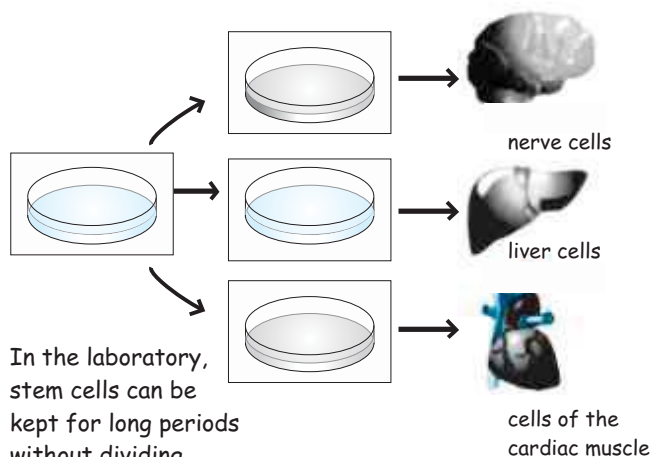

In the laboratory, stem cells can be kept for long periods without dividing. Different kinds of cells can be created to suit different needs.

In animals, after they reach a certain stage in their growth, most of the cells stop multiplying. But there are a few cells that retain their ability to divide. These are known as stem cells. When cells in a particular organ of the body die, these stem cells create new cells and repair the damage. When a stem cell divides, one of the two cells differentiates and becomes a cell of the tissue while the other retains its stem cell status.

Scientists have succeeded in discovering such stem cells that are able to generate cells not only for their related organ but for other organs as well. Efforts are being made to recreate damaged organs with these stem cells.

Cell theory: The journey ahead

The cell theory, to a large extent, rests on the fact that all living organisms are made of cells and all their life processes occur at the level of cells. In other words, there is no other level of organization of life lower than a cell. Cell is the minimum unit of organization that exhibits the characteristics of life. However, this does not mean that a single cell of a peepul tree can be considered an entire tree. Cells form tissues, tissues get together and form organs, all the organs synchronise to create an organ system and the co-ordinated functioning of the systems make an organism. Therefore, an organism is not just a mass of cells. It is only a specific organization of cells that can give rise to tissues, organs, systems and finally the organisms.

There is another thing that must be borne in mind — cells in different organisms perform almost similar tasks; their respiration is similar, mode of nutrition too happens to be similar, process of division also occurs in the same way. Yet, they are different. In every cell there are certain activities that are common to all cells, while a few of these are unique to that particular cell. In other words, all cells execute certain common functions. In this sense, cells are autonomous living units. But each cell also performs certain activities as part of a larger living organism. In this sense, it is a structural unit of that organism.

Differentiation in cells

The process by which differences occur in the structural and functional aspects of the cells in various organs of the organism is known as cellular differentiation. For example, after a seed is sown roots, stem, leaves, flowers are formed from it. Even within leaves there are different kinds of cells. While studying the life-cycle of frog we saw how different kinds of cells are formed

from a single cell to create the whole animal. This is the consequence of cellular differentiation.

However, in this regard, there is a significant difference between plants and animals. In general, the process of differentiation in plants is not permanent. If we plant a twig, it will eventually be transformed into a fully-grown tree. But this does not happen in most animals. Hence, in general, cloning animals is quite a challenging task. You may have already read or heard that, scientists have made a lot of progress in the field of cloning animals. For the past few years, they have been thinking about cloning human beings as well. This involves quite a few ethical issues.

We saw that in the course of the development of cell theory it slowly came to light that the entire structural and functional information of the cell is stored in the nucleus. Within the nucleus, this information storehouse has been traced to the chromosomes.

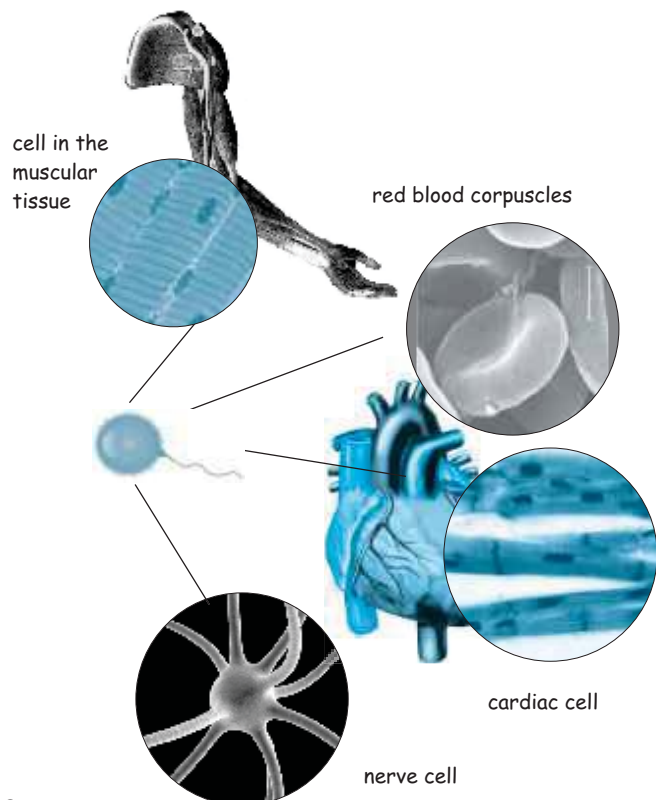

Cloning

Each cell in an organism has a definite number of chromosomes. At the time of sexual reproduction, special cells are produced, in both the male and female organisms, which have half this number of chromosomes. Next, the male and female reproductive cells, the sperm and the ovum respectively, fuse and fertilisation takes place. The cell thus generated, the zygote, has the usual number of chromosomes. This is normal sexual reproduction. It is obvious that half of the chromosomes in the zygote come from the male and the other half comes from the female parent. In this manner, the offspring inherit the traits of the mother and the father.

If you take a cell from only one individual (either male or female) and create a new organism from it, then this organism will receive all its chromosomes from either the mother or father and so it would be a perfect copy of the mother or the father. This is called cloning. However, it is not very easy to achieve this in the case of animals and a lot of effort has gone into meeting this challenge. So far, it has only been possible to create rats or sheep by cloning. However, scientists have enough knowledge and experience to be able to create human clones as well.

Many people feel that cloning humans would be going against nature. Hence, such an attempt should not be made. On the other

hand, a few people believe that this will actually be a great advance in medical science. They feel that an organ or tissue could be cloned instead of the entire animal. If a person damages a particular organ or a tissue then a clone organ or tissue could be used for treatment. Or, an entire person could be cloned and the clone's organs could be used as and when required.

But the question is what would be the rights of this clone whose sole purpose in life would be to supply spare parts even though it is normal human being? Then What is the meaning of its existence?

Another question that emerges is who is the clone actually? If it is the same person whose cloning has been done, then how would the clone be related to the original? For example, if a woman gives birth to her own clone, what would be their relationship? Would the clone be her daughter, her sister or her own self?

Such questions are coming to the fore vis-à-vis human cloning. In fact, many countries have banned experiments in human cloning while some scientists are demanding that the ban be lifted.

Incidentally, besides cloning entire organisms, tissues and organs, this technique has been quite effective in the field of gene cloning. Through this technique, we can use the genes of one organism in some other organism.

Gradually, it has also become apparent that the nucleus does not control cells entirely autonomously. The cytoplasm too has some control over it.

The manner in which nucleic acid regulates the characteristics of the cell has become clear to a certain extent. We have also come to know that the traits of the parents are passed on to their offspring through nucleic acid. The units of nucleic acid that determine various characteristics are known as genes. Today we can even confidently

say where many of these genes are located on the chromosomes.

We have also begun to insert the gene from one organism into the genome (i.e. the collection of all the genes) of another organism. This technique has produced genetically modified organisms. This too has given rise to intense social debates.

Hence, we can say that the cell theory has come a long way since its beginning in the early 19th century, and it seems that it has a long way to go.

If possible please edit the matter for fit the page

Development of the Life Sciences

The development of cell theory has played a significant role in unifying the entire living-world. We have realised that organisms that appear to be so different are fundamentally very similar. We have also been able to understand the basis of differences seen between different life forms, and the process by which these differences are

created. While the theory of evolution provides us with a framework for establishing links between living beings, the cell theory facilitates understanding the manner in which life is governed at the level of cells. This theory weaves together the diverse life-forms in a single strand.

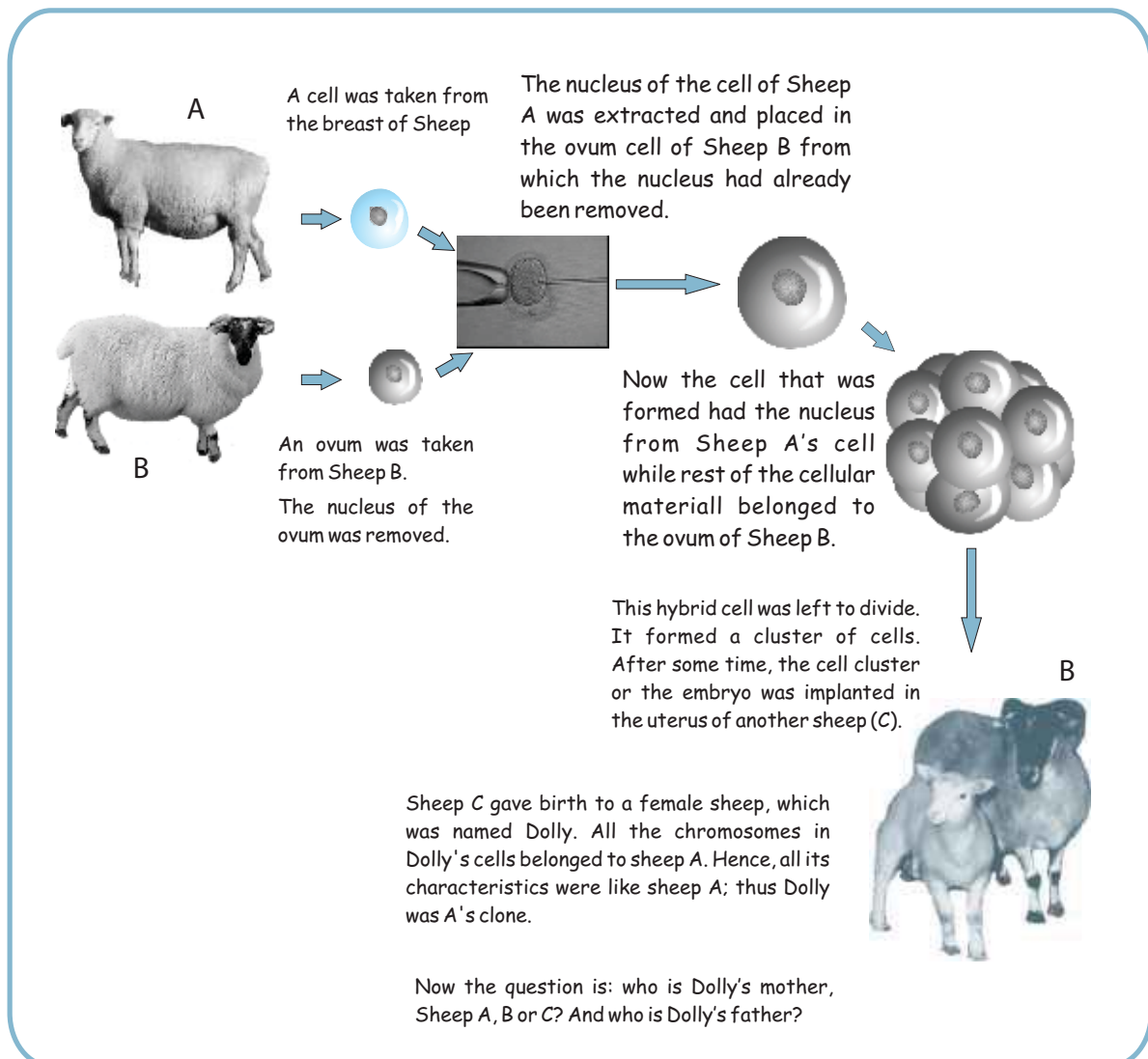

Genetic Engineering

In nature, genes are exchanged only among organisms from the same species. But today biologists have developed techniques that help them take a gene from one organism and transplant it in the gene sequence of any other organism, no matter what species it belongs to.

As a result, genes are being transplanted to and from totally unrelated organisms. This has resulted in making the species barrier to gene flow less rigid.

For example, you must have heard about Bt cotton. In this, the gene from a bacterium named Bt has been implanted into cotton plants. It is believed that Bt produces a chemical that kills a particular pest. By inserting its gene into the cotton plant, it has been possible for the plant to produce the same chemical as well. It is being claimed that now those pests will not feed on the Bt cotton plants. This would reduce the use of pesticides.

However, a few people believe that the pest would develop immunity towards the poison generated by the plant very soon due to continuous exposure. Some people even contend that this gene could reach the cells of weeds, whereby the weeds would become resistant to the same pests and so it would get increasingly difficult to control the weeds.

Some people are also apprehensive about safety issues in consuming genetically-modified food.

People are also concerned about where this process of gene transfer might lead us. For instance, certain traits are considered desirable in our society. The concern is that

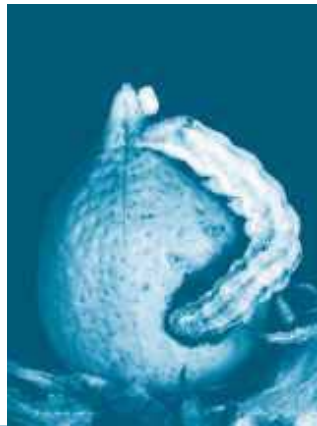

Figure: Cotton-boll larvae (*Helicoverpa armigera*) feeding on cotton bolls. The Bt cotton has been grown to resist these and larvae of other pests.

parents might want to use gene transfer to implant these “desirable” genes in their children. And who is to decide which qualities are desirable? There is an anxiety that this may encourage our social prejudices. For example, in Indian society there has always been a great desire for male progeny, but for a long time there were only limited means for fulfilling the desire. But nowadays, through the techniques of ultrasonography and amniocentesis people are electing to have only boys. The social consequence of this is evident in the decreasing number of girls in our population. Genetic

engineering has the infinite potential to fuel our social prejudices.

However, a question still remains. It is true that like any organism, the cell is also formed from a pre-existing cell. But then, how was the first cell formed? In other words, how were inanimate materials first organised to acquire the characteristics of life? How did the first cell come into being? That is to say, what were the conditions under which inanimate materials created living organisms spontaneously? With this, we bring an end to our discussion because if we start talking about all this, then the discourse might go on for ever.

none

Milestones in the study of cells

- 1590s:** Janssen discovers the compound microscope
- 1665:** Robert Hooke describes cork cells
- 1668:** Francesco Redi refutes theory of spontaneous generation
- 1674:** Leeuwenhoek first sights microscopic organisms
- 1676:** Leeuwenhoek observes bacteria
- 1831:** Robert Brown sights the nucleus in orchid cells
- 1839:** Schleiden and Schwann propounds cell theory
- 1840:** Albrecht von K lliker discovers that sperm and ovum are also cells
- 1856-58:** N Pringsheim views sperm cell entering the ovum
- 1857:** Kolliker sights the mitochondria

Leeuwenhoek: sights microscopic organisms and bacteria

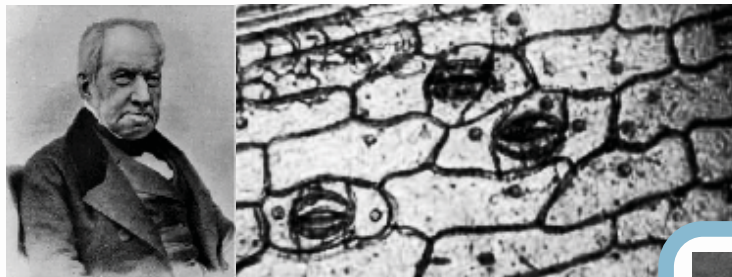
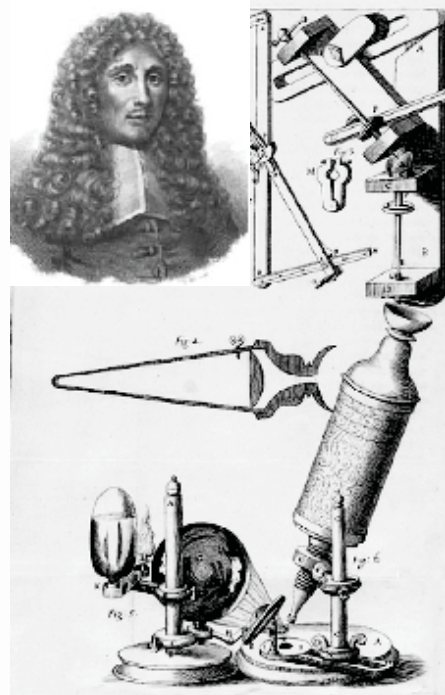

Robert Brown: nuclei in orchid cells

- 1858:** Rudolph Virchow propounds the *omnis cellula e cellula* theory
- 1869:** Miescher separates the DNA
- 1879:** Fleming notices the role of chromosomes in cell division



Rudolph Virchow:
Omnis cellula e cellula

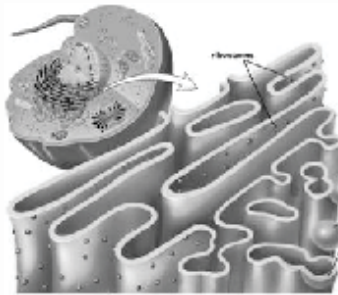

Camillo Golgi: description of Golgi apparatus



Ruska: electron microscope



Francis Collins:
mapping of human genome



Watson and Crick



Rosalind Franklin:
double helix structure of DNA comes to light

- 1883: Reproductive cells are haploid in nature
- 1898: Camillo Golgi describes the Golgi apparatus
- 1902: Chromosome theory in genetics is prepared
- 1924: Discovery of the first ultracentrifuge
- 1932: Ruska makes the electron microscope
- 1953: The double-helix structure of DNA comes to light
- 1955: Eagle found out the nutritional requirement of the human cell in artificial medium
- 1982: Genetically-engineered mice created
- 1996: Cloning in sheep results in the birth of Dolly, first mammal clone
- 2000: Human genome mapped
- 2003: First cloned rat created

Appendix

Appendix 1

Know the microscope

The microscope is an extremely important instrument for both teachers and students of biology. To use it properly, one must understand the structure and function of its parts.

There are two kinds of microscopes: simple and compound. In the simple microscope there is a single convex lens while in the compound microscope there are two convex lenses kept at a fixed distance from each other. One lens enlarges the image of the object (magnified image) while the other magnifies this image even more. Here we will only talk about the compound microscope. Incidentally, all the preliminary observations of cells were done with a simple microscope.

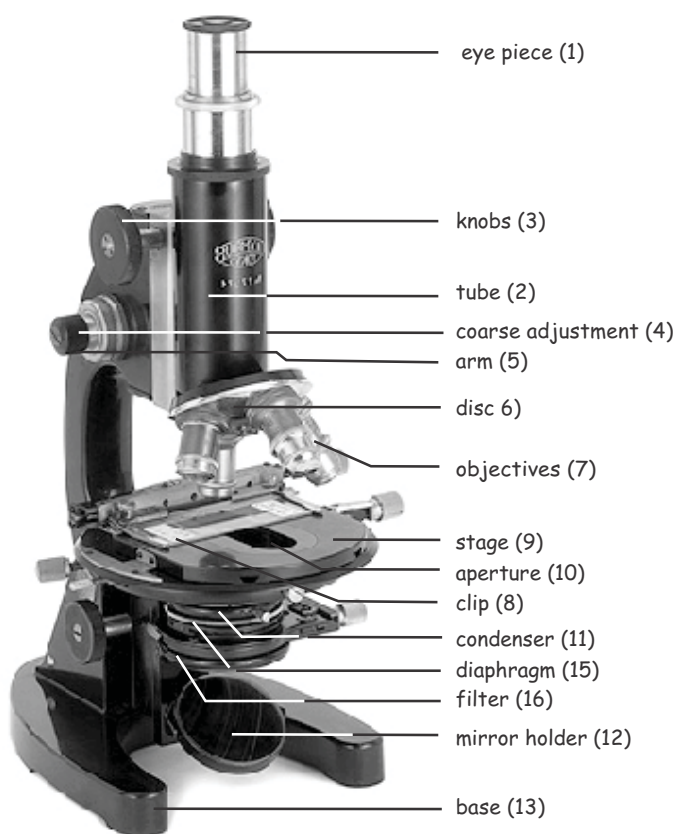

Image: 40

Introduction to the microscope

Microscope is made of heavy moulded metal and hence, does not topple easily. It has the following parts:

There is a U-shaped base (base, 13) that keeps the microscope stable. The instrument should be kept on a level surface.

A C-shaped arm (arm, 5) juts above the base. A vertical tube (tube, 2) is affixed at its upper end. This tube can be moved up and down.

Two pairs of circular knobs are attached to the arm to move the tube up and down. The bigger knob (3) moves the arm in broad grooves so that it moves a greater distance with each turn. This leads to coarse adjustment of the image. The smaller knob moves the arm in finer grooves and the position of the tube changes slightly; this leads to fine adjustment of the image and helps in obtaining the right focus.

A pair of lenses is fixed in a cylindrical casing at the upper end of the tube. This casing can easily slide into the upper portion of the tube. There is a tiny aperture on the upper lid of the casing. For observation under the microscope you need to look through this aperture. Hence this casing is called the eye piece. The magnification

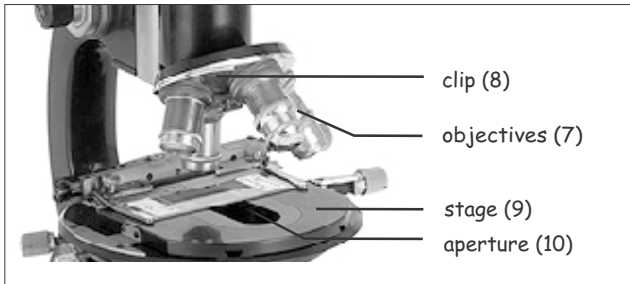

of the eye piece is mentioned on it, for example 5X, 10X etc.

A small metal disc (disc, 6) is fastened to the lower end of the tube in such a manner that it can be freely rotated. This disc has 3-4 threaded apertures in which lens sets can be fastened.

Each such set of lens is fixed in a cylindrical casing, with threads on its base. With the help of the threads, the lens can be fastened in the aperture. These lenses are called objectives (7). You can rotate the disc to bring the required objective in alignment with the eye-piece. The magnification of each objective is mentioned on it.

Just below the objective, there is a platform (9). This is called the stage. There is a circular aperture (10) at the centre of the stage through which light can pass and fall on the objective. There is a clip (8) on both sides of this aperture.

The magnification of the microscope is equal to the product of magnification of the eye piece and the objective. For example, if the magnification of the eye piece is 10X and that of the objective is 45X then the object would be seen magnified 450 times under the microscope.

During observation, the slide is held under these clips. In some microscopes there is a holder instead of clips. There are knobs on the holder with which the slide can be moved in all directions on the stage. There is also a scale on the holder that helps one to note how much the slide has been moved or which part of the slide is under the objective.

There are a few other parts under the stage that are as follows.

- a) A circular mirror holder (12) that contains a concave mirror on one side and a plain mirror on the other. The mirror is kept at such an angle that after reflection light passes through the aperture of the stage and falls on the objective.

There are a few rings just above the mirror that hold the following parts:

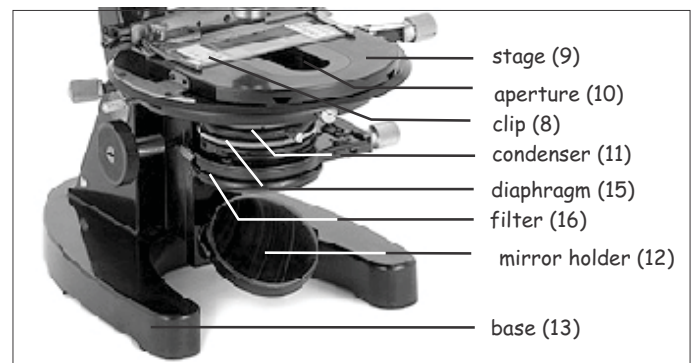

- b) A convex lens called condenser (13) can be adjusted with the help of a knob (14) to allow maximum light to reach the aperture.
- c) There are several plates arranged in such a manner as to have a tiny hole in the middle. These plates can be adjusted to make the hole larger or smaller. This is known as the diaphragm (15).

If need be, this can be adjusted in such a manner that a thin ray of light passes through this and directly illuminates only the area that is being observed. This helps in sharper observations.

- d) On another ring there is a blue-coloured ground glass called filter (16). This is normally used to view the objects in artificial light.



Using a Microscope

- i. Put one or two drops of water on the material and cover it with a cover slip.
- ii. Place the microscope in such a manner that the light comes from the front.
- iii. Keep the slide on the stage in such a way that the object rests directly on the aperture of the stage.
- iv. Adjust the plain mirror so that maximum light reflected by the mirror reaches the object.
- v. Move the condenser up or down and look through the eye-piece to check that maximum light is reaching the object.
- vi. If there is no condenser, make use of the concave mirror.
- vii. Adjust the aperture in the diaphragm; look through the eye piece to ensure that only the object is illuminated.
- viii. Bring the low magnification objective (4X or 10X) over the object.
- ix. Viewing through the eye piece, move the tube up or down with the coarse adjustment knob and try to bring the object into focus.
- x. Using the fine adjustment, sharpen the focus.
- xi. To use the higher magnification lens, move the tube up, rotate the circular disc and bring the required objective (10X, 45X) into place. Now slowly bring down the tube, looking at it from the outside, till the objective lens almost touches the cover slip. Look through the eye piece and slowly bring the tube up with the help of fine adjustment till the object comes into sharp focus. This process reduces the possibility of breaking the cover slip or the slide.

A few tips

The lens of the microscope needs to be cleaned with distilled water or xylene or a mixture of chloroform and xylene. Alcohol should not be used for cleaning as it dissolves the adhesive used to fasten the lenses.

The lens should be cleaned with a piece of soft cloth, preferably one which does not shed fibres. A soft brush could also be used to clean the lens. Make sure you do not move the cloth or the brush in circles. This might lead to the dust particles scratching the lens. Move the cloth or the brush in straight strokes and lightly wipe the lens.

In some microscopes there are two eye-pieces instead of one. Such microscopes are called binocular microscopes. The advantage is that this can be used for a long time without straining the eyes. A microscope with a single eye piece is known as a monocular microscope. While observing through the monocular microscope you need to get used to keeping both the eyes open. This will cause less strain on the eye that is being used.

To prepare a permanent slide, the material is mounted in a drop of some special liquid. It keeps the material uncontaminated in addition to preserving it.

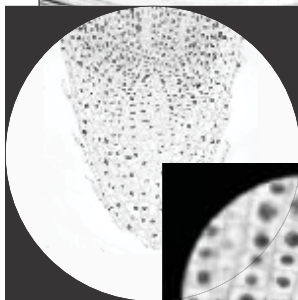

4X

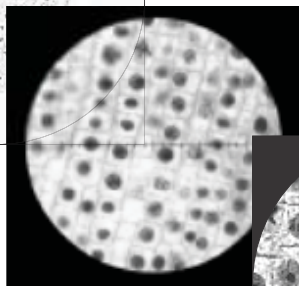

40X

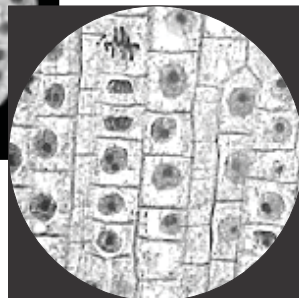

400X

Image: 41

Appendix 2

Are cells flat?

Usually when cells are seen under the microscope, the image appears as flat and two-dimensional. It seems that all the organelles in the cell are situated in one plane. This is very similar to how stars appear to be on the same plane, whereas in reality they are at different distances from the earth. This perception of flat cells gets reinforced when we see the two-dimensional images printed in books.

We have tried to include more three-dimensional images.

In reality, cells have length, breadth and also depth. We can easily see the length and breadth. Since we cannot see the depth of the cells under the microscope, we tend to think that these are flat objects. However, there are a few easy ways to observe the thickness of the cells. The easiest method is to slightly change the focus while viewing plant cells on the slide and look at the cell wall. You'll find that you are able to see the depth of the wall. This three-dimensional figure becomes clear if you reduce the intensity of light as well (see figure 42).

You may have noticed that many of the diagrams given in this module have three-dimensional

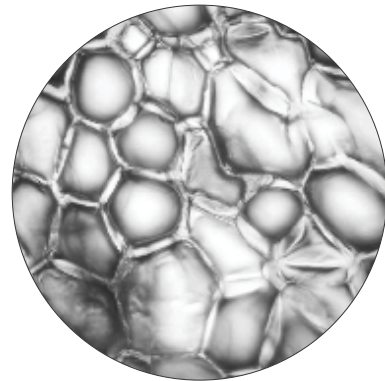

Figure: 42

effects. We feel that more such figures need to be used to understand the inner structure of the cells.

Objects are three dimensional in nature but if you view them from one side, they will appear as two-dimensional. Hence, to appreciate all the three dimensions, we need to usually look at sections of the object cut at different angles. Let's take an example. Figure 'a' is a photograph of an onion that gives us a three-dimensional feel. But from this we hardly get an idea of its internal structure. To know about its inner structure we take a longitudinal section of the onion (figure 'b'). From this we get an idea that the internal structure of



image a



image b

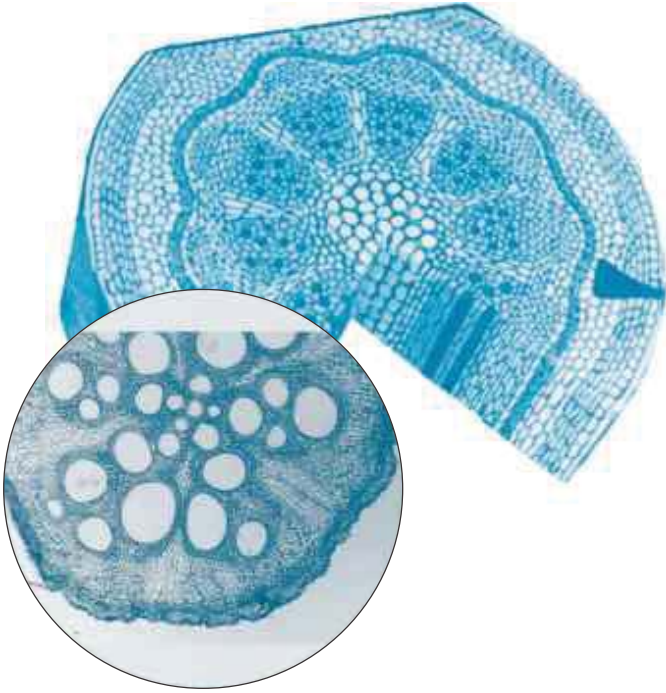

image c



image d

three dimensional model of a stem



a section of a stem

Figure: 43

the onion is made up of thick leaves. To see how these leaves are arranged, we take a cross-sectional of the onion (figure 'c'). In reality, to understand the entire inner structure we would need various sections of the onion (figure 'd') and, based on those, prepare a integrated picture of the structure.

We adopt a similar process to understand the internal structure of organisms. For example, figure 43 shows the three-dimensional model of a stem. This model has been prepared on the basis of several different sections of the stem.

This is very similar to a building plan. For a house we need to prepare a ground plan and a front elevation. If you only see the ground plan, you would get the feeling that the house is flat. Similarly, if you only see the front elevation, the house would still appear flat. Only when you see both the plans together will you be able to visualise the three-dimensional house in its entirety.



In this section, we give a few more activities. By doing these, children would develop a better idea about cells and their organelles.

1. Observing the mitochondria

To observe the mitochondria, take leaves of pawar (Cassia tora) or lily, onion peel or cheek cells. Make a fresh solution of Janus Green-B in a watch glass (to make this solution mix 200 mg Janus Green-B in 100 ml of water). Put the material, say the onion peel, in this solution and keep it for about half an hour. After half an hour, cut a 2 mm² piece from the peel, keep it on a slide and wash it thoroughly with water. Now cover the slide with a cover slip and observe it under high magnification.

You will see quite a few green oval or cylindrical grains scattered in the cytoplasm. These are the mitochondria.

2. Observing the skin of a frog

Catch a frog and with a sharp knife scrape off some portion of its skin. Now spread the piece of skin evenly on a slide and add 1-2 drops of water, cover it with a cover slip and view it under the microscope.

3. Muscle cells

If possible, buy some meat from the market. Place it on a slide and separate the fibres with the help of a needle. Now keep one or two fibres and remove the rest. Put 1-2 drops of water on these, cover it with a cover slip and observe it under a microscope.

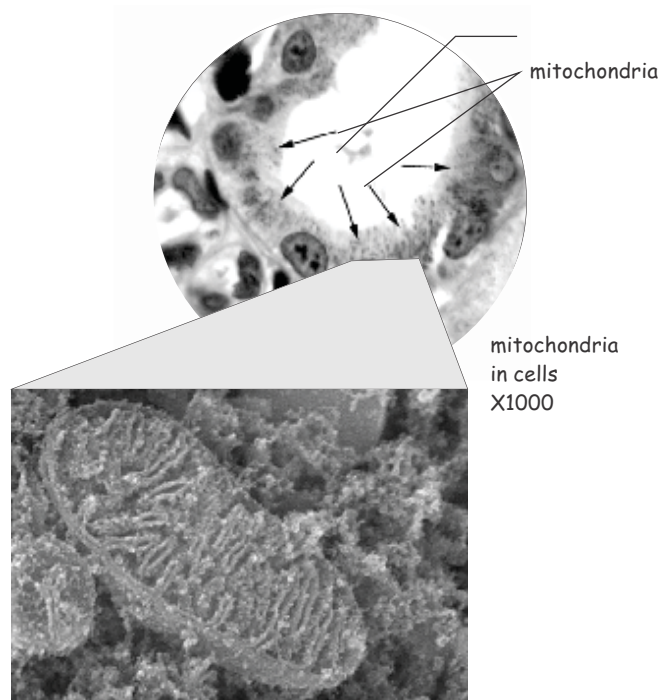

Image: 44

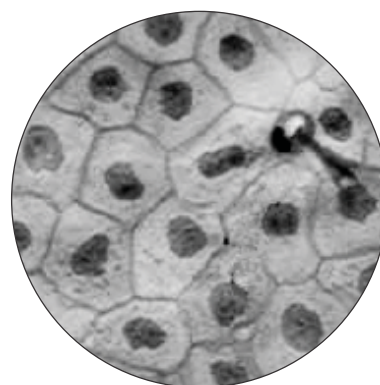

Image 45:
Skin of frog as seen under
microscope X ...

4. Blood cells

While studying life-cycle of a frog, you can observe an interesting thing in tadpoles. Place a live tadpole on the slide and cover its head and upper half of the body with wet cotton. Only leave the tail exposed. Observe its tail under the microscope; you need not use a cover-slip over the tail. You will notice blood cells streaming one behind the other like the coaches in a train along the edge of its tail.

5. Cross-section of a leaf

You have already observed a leaf peel. Now you can observe cross-section a leaf. Take a Rhoecolobum or any other leaf, and roll it into a tube along its length. Now take a blade and make very

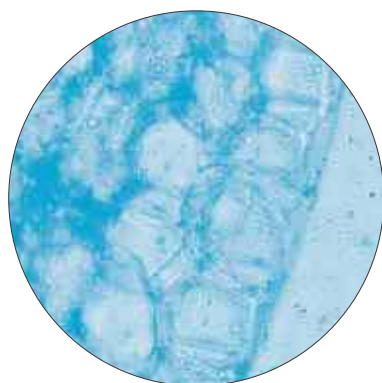

Figure 46: Cross-sectional slice of a leaf X 200

thin sections of the leaf, in the same manner in which you had earlier sectioned the stem. Take a thin section, place it in a drop of water on a slide, cover it with a cover slip and observe it under the microscope. You will be able to see the entire structure, right from the upper surface to the lower surface. From this, you will also be able to get an idea about the diversity of cells.

We have already seen a few living organelles found in the cell. In the course of its regular functioning, the cell produces many substances. Occasionally these substances are found in specific deposits within the cell. These are known as cell inclusions. These are inanimate objects found in the cells. Let's try to see some of these.

6. Starch particles

Cut very thin sections from a potato. Now place one such section on the slide in a few drops of water, cover it with a cover slip and observe it under the microscope. Try to spot the shining structures in the cell.



Figure 47: starch particles in a potato slice

Now put 1-2 drops of iodine solution on this section and leave it for about five minutes (to make iodine solution, buy some tincture iodine from a pharmacy and dilute it with twice the amount of water). Now observe it again. The particles of starch react with the iodine and appear as dark spots on the section.

7. Needles

Take a leaf from a money plant or from a yam (arabi, ghuiyan) plant. Take a thin cross-section of its petiole/main vein or extract a peel from the leaf. If you observe it under the microscope, you will be able to see needle-like structures in it. The needles mostly appear in bundles. You will be able to see similar crystalline structures in the section of a yam tuber as well. These are calcium

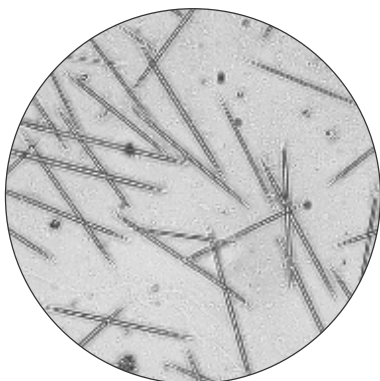

Figure 48 caption: Needles X 200

oxalate crystals. Because of these crystals we sometimes experience an itching sensation while eating the yam leaves in different dishes.

8. Stars

You might be familiar with the cactus plant. Break off a small portion from the plant and take thin sections from it. Now observe the sections under the microscope. You will be able to see

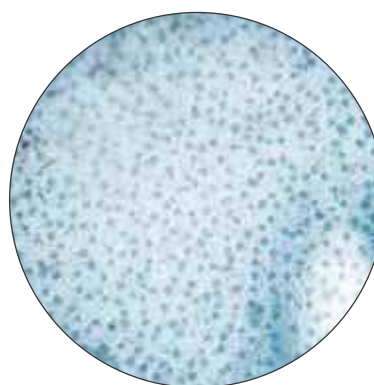

Figure 49:
stars in the cactus plant X 200

star-shaped or prickly ball-like structures in its cells. These are known as druses. These are also crystals of calcium oxalate. Similar crystals are found in leaves of the calotropis plant too.

9. Cystolith

Cystolith is another structure found in cells of some leaves. To observe these structures, cut a thin cross-section of an oleander or banyan leaf, just the way you had done for the Rhoeo leaf. Observe this section under the microscope. While noticing variety of cells, focus your attention on the outermost layer of cells (epidermis). Here you'll see structures that look like bunches of grapes. These are cystoliths. These are actually crystals of calcium carbonate.

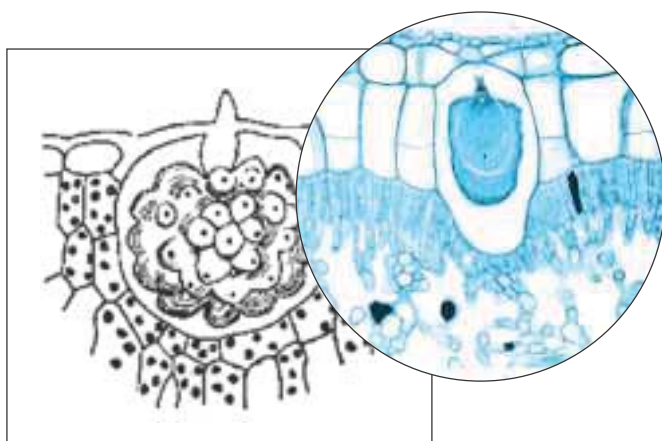
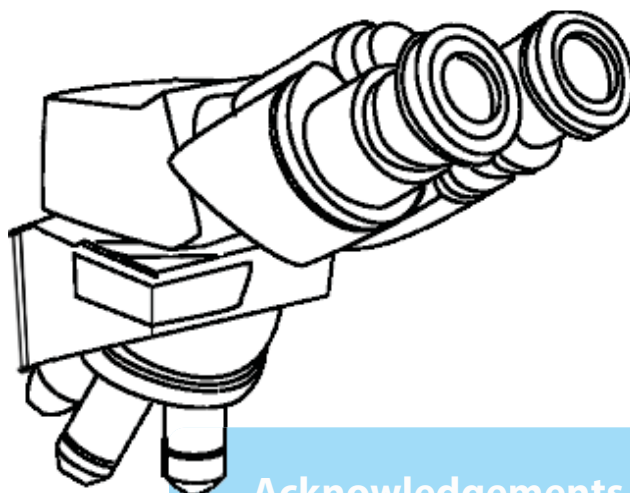

Figure 50: cystolith



- Acetabularia, box, image
- Amniocentesis
- Amoeba, image
- Animalcule
- Aristotle
- Bacteria, image
- Benda, Carl
- Blood cells
- Brown, Robert, image
- Bt, Bt cotton
- Budding
 - Budding in yeasts, activity
- Cancer
- Cell wall
- Cell: chemical structure
- Cell theory
 - and genetics and nervous system, box
 - cell, first understanding
 - evolution
 - independently alive units
 - milestones
 - minimum structural unit
 - structural and functional unit
- Cell to cell
 - cellular cycle
 - cell and reproduction
 - cell division
 - cell division in animals
 - cell division in root cells of onion activity, image
 - chromatin
- Cell organs
- Cells, many shapes, many sizes, box
- Cell membrane
 - identifying image
 - observation, activity
 - selective permeability
- Cell's powerhouse
- Cell: Flatness and three-dimensional structure
- Cells in the mouth, activity
- Cells in curd, activity
- Cellular pathology
- Centrifuge
- Chloroplast, image
 - in rhoeo, activity
 - in hydrilla, activity
 - of different shapes, activity
- Chromoplast
- Chromosome, image
- Cloning, box
- Compound microscope
- Cork
 - slice of cork, image
 - thin slice, activity
- Cross-sectional slice of leaf, activity
- Cross-sectional slice of stem, image
- Cystolith
- Cytoplasm
- Cytoskeleton
- Darwin, Charles
- Destructive enzyme
- Development of organism
- Dieter, Karl
- Differentiation
- DNA
- Drops of water, activity
- Electron microscope
- Endoplasmic reticulum
- Epithelium
- Ergastoplasm
- Euglena, image
- Eukaryotic cells
- Fleming, Walther
- Fontana, Felice
- Genetic material
- Genetic engineering, box
 - and social prejudice
- Gene, gene clusters, genome
- Genetically engineered organism
- Golgi body
- Golgi, Camillo, image
- Gwarpathe ki patti ka avalokan???

Hämmerling, Joachim
 His, Wilhelm
 Hooke, Robert
 Intracellular fluid
 organic fluid vs cell fluid
 Janssen
 Kircher, Athanasius
 Leeuwenhoek, Antonie von, image
 animalcule made by him, image
 his microscope, image
 Leucoplast
 Life-cycle of fly, activity
 Life-cycle of frog, activity
 Lysosome
 Match-stick slices, activity
 Matrix
 Mesophyll
 Microscope
 Mitochondria, image
 observation techniques
 under electron microscope
 Mitochondria and chloroplast
 Muscles, activity
 Needles in yam leaves, activities
 Nucleus, image
 determination of genetic trait
 nuclear fluid
 nuclear membrane
 nucleus in orchid cells, image
 Nucleic acid
 Nucleus
 nucleus in onion cells, image, activity
 Nucleoplasm
 Observing the skin of frog, activity
 Onion membrane, activity
 Orchid, image
 Origin of organisms
 Optic microscope
 Ovum
 Palisade cells
 Paramecium
 Pasteur, Louis
 experiments by Pasteur, image
 Phloem sieve tube
 Photosynthesis
 Plastids
 Prokaryotic cell
 image
 Prototype cell, image
 an overview
 animal and plant cell
 difference between plant and animal cells
 prototypical animal and plant cell
 similarities in the plant and animal kingdom
 Red blood corpuscles, image
 Redi, Francesco
 Redi's memorable medal, image
 Ribosome
 protein formation
 Riktikayen???
 RNA
 Royal Society of London
 Ruska, Ernst August Friedrich
 Salamander
 Schleiden, Matthias, Jacob, image
 Schwann, Theodor, image
 Simple microscope
 Sperm
 Spontaneous generation theory
 Staining
 Janus green-B
 fluorescent staining
 Methylene blue
 Safranin
 Starch particles observation, activity
 Stem cells
 Strasburger, Eduard, Adolf
 Suicidal sac (lysosome)
 Swamdem yan???
 Ultrasonography
 Unicellular organism
 Vesicles
 Virchow, Rudolph, box, image
 Yeast
 budding in yeast, activity
 yeast cells, activity



Acknowledgements

This module is the outcome of joint efforts of some biology teachers and other individuals concerned with education. Conceptualization and actual writing of the module was done by Anil Dikshit, Arvind Gupte, Bharat Poorey, Kishore Pawar, Bholeshwar Dubey, Sushil Joshi, Javed Siddiqui and Uma Sudhir. The framework of the module was greatly influenced by the textbook prepared by Biological Curriculum Study Committee.

Besides these people there were also others who read different drafts of the module and enriched it with their feedback and comments from time to time. Among them are Ashok Sharma, Satyajit Rath, Vinod Raina, Neeraj Jain, SC Arunan, Karen Haydock and Sumit Tripathi.

The module has been tried out at various levels. There have been two different kinds of trialling. At one level different portions of the text and related activities were tried out with multiple groups of teachers and students. In addition, the entire module was also done with the teachers associated with Vidya Bhawan Education Resource Centre, Udaipur. Their feedback too has helped in making the module practicable.

Design and Layout of the module has been done Amod Karkhanis, with significant inputs from Karen Haydock and Meghna Palshikar. A few photos have been taken by Kishore Pawar.

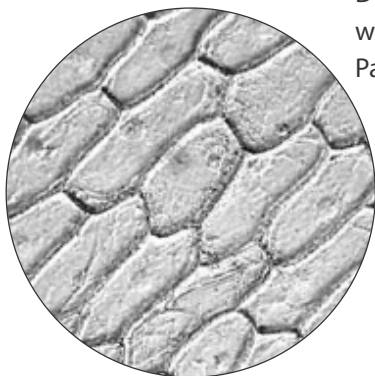

Eklavya

Eklavya is a voluntary organisation working in the area of education and popular science for the past several years. Eklavya is active in educational activities within and outside schools.

The primary aim of Eklavya is to work towards an education that is relates to children and their immediate environment; that is based on games, activities and creative aspects. In the course of our work we have found that the efforts made within schools can only be successful if materials for creative activity are also made available to the children outside school and at home. Books and magazines are important parts of this resource.

For the past few years we have also expanded our work in the area of publication. Apart from the children's magazine Chakmak, we also regularly publish Srote (features on science and technology) and Shaikshanik Sandarbh (educational magazine). Apart from materials related to education and popular science and creative activities for children, Eklavya has created and published books, pamphlets and materials on various issues related to development.

Presently, Eklavya functions through its centres located at Bhopal, Hoshangabad, Piparia, Harda, Dewas, Indore, Ujjain, Shahpur (Betul) and Parasia (Chhindwara).

We invite suggestions on the content and design of this book. This will help us, in future, to create books that are more attractive, interesting and useful.

Contact us: books@eklavya.in

E-10. Shankar Nagar, BDA Colony,
Shivaji Nagar,
Bhopal-462016